

UEX3C-KIT

Quick Reference Guide

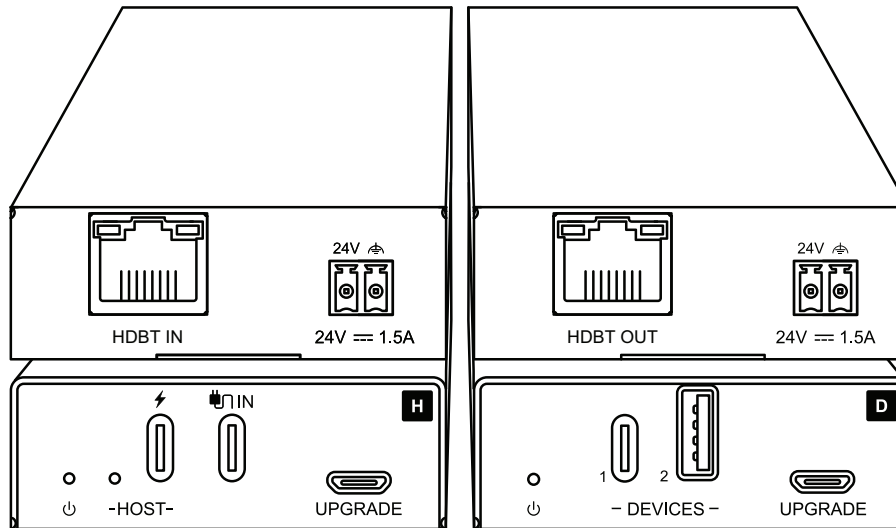

Introduction

The UEX3C-KIT is a USB extender kit utilising HDBaseT™ technology to extend USB 3.2 Gen1 signals up to 100m over a single CAT cable. The UEX3C-KIT allows up to 2 USB devices to be connected to a single USB host with support for a transmission data bandwidth up to 5Gbps. The UEX3C-KIT is backwards compatible with USB 2.0 and 1.1 devices and provides bi-directional Power over Cable (PoC)

The UEX3C-KIT is ideal for applications requiring extension of USB 3.2 Gen1 conferencing cameras, video capture devices, Flash/hard drives, KVM devices, audio devices and other USB 3.2 Gen1 devices

FEATURES:

- Supports USB 3.2 signal extension up to 100m*
- Backwards compatible with USB 2.0 & 1.1 devices
- USB3.2 Gen1 data transfer rate up to 5Gbps*
- 1x USB-C port on the receiver for connection to host device
- 1x USB-C host charging port for connection of external power supply to power host device
- 1x USB-A & 1x USB-C port on transmitter for connection to devices
- Provides up to 2.5A combined power to USB devices (up to 1.7A per single USB port)
- Configurable USB device power management via API commands
- Bi-directional PoC (Power over Cable) to power extenders from either the host or device unit
- PoC function can be enabled/disabled via dipswitch
- Simple plug and play, no driver installation or setup required.

*Signal distribution bandwidth and length are subject to length of device and host USB cables and CAT cable type

Host Panel Descriptions

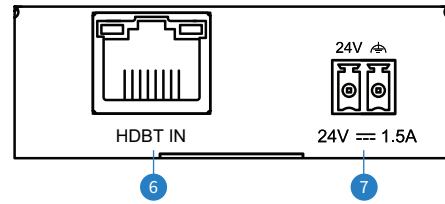
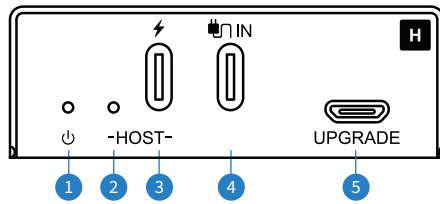

- 1 Power Status Indicator - Illuminates when UEX3C-H is powered on
- 2 Host Status Indicator - Illuminates when a USB Host is connected
- 3 Host Input - USB-C port connects to USB Host (PC / Laptop). Can provide charge to Host if USB-C Charge Input port is connected to compatible USB-C power supply
- 4 Charge Input - USB-C port connects to compatible USB-C power supply (not included)
- 5 Upgrade Port - Micro USB port for firmware upgrade and servicing
- 6 HDBaseT Input - RJ45 connector connects to HDBaseT Output on UEX3C-D
- 7 Power Input - 2-pin Phoenix connector connects to 24V/1.25A DC power supply

Device Panel Descriptions

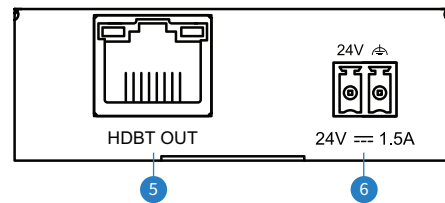
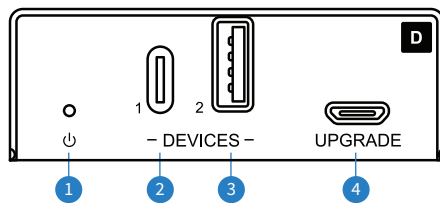

- 1 Power Status Indicator - Illuminates when UEX3C-D is powered on
- 2 USB-C Device Input - Connect to USB-C device such as keyboard/mouse/camera, etc...
- 3 USB-A Device Input - Connect to USB-A device such as keyboard/mouse/camera, etc...
- 4 Upgrade Port - Micro USB port for firmware upgrade and servicing
- 5 HDBaseT Output - RJ45 connector connects to HDBaseT Input on UEX3C-H
- 6 Power Input - 2-pin Phoenix connector connects to 24V/1.25A DC power supply

Side Panel Descriptions

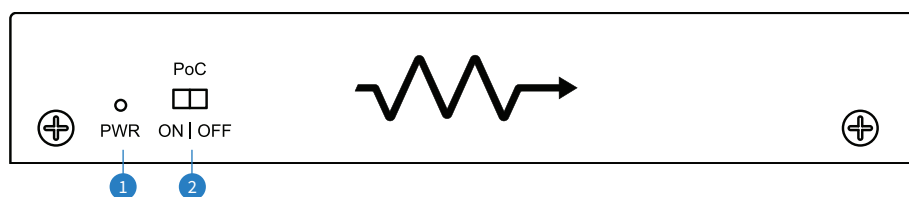

- 1 Power Reset Button - Press to reset unit
- 2 PoC On/Off Switch - Enables or Disables Power over Cable (PoC) to power connected unit

Terminating the Interconnecting HDBaseT™ CAT Cable

It is important that the interconnecting CAT cable between the Blustream HDBaseT™ products is terminated using the correct RJ45 pin configuration. The link CAT cable **MUST** be a 'straight' (pin-to-pin) CAT cable and it is advised that this is wired to the T568B wiring standard as this format is less prone to EMI (Electro-Magnetic Interference).

When installing CAT cables, it is advised that you use the best possible CAT cable quality possible. HDBaseT™ products using the VS6000 Stello chipset (HDBaseT™ 3.0) require a minimum grade of CAT6A cabling, by specification, to ensure stable distribution of USB-C signals over distances up to 100m.

Please note: using a reduced grade of CAT cable that does not feature the same level of immunity to outside interference, insufficient bandwidth, or passing through connections (i.e. patch panels or in-line connectors), will lead to an unstable distribution of the high-bandwidth signal used in HDBaseT™ 3.0 products. Blustream recommend using CAT6A F/UTP, or better, for use with the UEX3C-KIT.

RJ45 Wiring - T568B

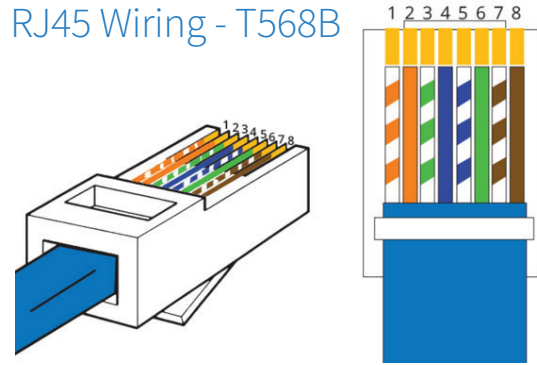

Understanding the HDBaseT™ Signal Status Lights

The Blustream HDBaseT™ extender solutions include status LED indicators on both the Transmitter and Receiver products to show all connections are active and to help diagnose possible problems.

Understanding the Status Lights:

- The orange HDBaseT link light will be off when there is no CAT cable / active HDBaset connection on the RJ45 HDBase port
- The orange HDBaseT link light will blink if there is an unstable connection between the Transmitter and Receiver
- The orange HDBaseT link light will be lit when a CAT cable is stably connected between the Transmitter and Receiver
- The green HDBaseT Data light will be off when no USB data signal is transmitted
- The green HDBaseT Data light will regularly flash when there is USB 2.0 data transmitted
- The green HDBaseT Data light will unregularly flash when there is USB data transmission fault
- The green HDBaseT Data light will be lit when there is USB3.0 data transmitted

Specifications

UEX3C-H

- **USB Host Connectors:** 1x USB-C, female
- **USB Charge Connectors:** 1x USB-C, female
- **CAT Connectors:** 1x HDBaseT™ RJ45 connector
- **Upgrade Port:** 1x Micro USB connector
- **Casing Dimensions (W x D x H):** 130mm x 61mm x 22mm
- **Power Supply:** 24V/1.25A DC, 2-pin Phoenix connector

• UEX3C-D

- **USB Host Connectors:** 1x USB-C, female, 1x USB-A, female
- **USB Charge Connectors:** 1x USB-C, female
- **CAT Connectors:** 1x HDBaseT™ RJ45 connector
- **Upgrade Port:** 1x Micro USB connector
- **Casing Dimensions (W x D x H):** 130mm x 61mm x 22mm
- **Power Supply:** 24V/1.25A DC, 2-pin Phoenix connector

UEX3C-KIT

- **Box Dimensions (W x D x H):** 215mm x 150mm x 63mm
- **Shipping Weight:** 1.0kg
- **Operating Temperature:** 32°F to 104°F (-5°C to +55°C)
- **Storage Temperature:** -4°F to 140°F (-25°C to +70°C)

NOTE: Specifications are subject to change without notice. Weights and dimensions are approximate.

Package Contents

UEX3C-KIT

- 1 x UEX3C-H
- 1 x UEX3C-D
- 2 x Mounting kits
- 1 x 24V/1.5A power supply
- 1 x Quick Reference Guide

Maintenance

Clean this unit with a soft, dry cloth. Never use alcohol, paint thinner or benzene to clean this unit.

Certifications

FCC Notice

This equipment has been tested and found to comply with the limits for a Class B digital device, pursuant to part 15 of the FCC Rules. These limits are designed to provide reasonable protection against harmful interference in a residential installation. This equipment generates, uses, and can radiate radio frequency energy and, if not installed and used in accordance with the instructions, may cause harmful interference to radio communications. However, there is no guarantee that interference will not occur in a particular installation. If this equipment does cause harmful interference to radio or television reception, which can be determined by turning the equipment off and on, the user is encouraged to try to correct the interference by one or more of the following measures:

- Reorient or relocate the receiving antenna.
- Increase the separation between the equipment and receiver.
- Connect the equipment into an outlet on a circuit different from that to which the receiver is connected.
- Consult the dealer or an experienced radio/TV technician for help.

CAUTION - changes or modifications not expressly approved by the party responsible for compliance could void the user's authority to operate the equipment.

CANADA, INDUSTRY CANADA (IC) NOTICES

This Class B digital apparatus complies with Canadian ICES-003.

Operation is subject to the following two conditions: (1) this device may not cause interference, and (2) this device must accept any interference, including interference that may cause undesired operation of the device.

CANADA, AVIS D'INDUSTRY CANADA (IC)

Cet appareil numérique de classe B est conforme aux normes canadiennes ICES-003.

Son fonctionnement est soumis aux deux conditions suivantes : (1) cet appareil ne doit pas causer d'interférence et (2) cet appareil doit accepter toute interférence, notamment les interférences qui peuvent affecter son fonctionnement.

CORRECT DISPOSAL OF THIS PRODUCT

This marking indicates that this product should not be disposed with other household wastes. To prevent possible harm to the environment or human health from uncontrolled waste disposal, recycle it responsibly to promote the sustainable reuse of material resources. To return your used device, please use the return and collection systems or contact the retailer where the product was purchased. They can take this product for environmentally safe recycling.





www.blustream-us.com
www.blustream.com.au
www.blustream.co.uk