

► PWR8IEC

User Manual

Thank you for purchasing this product.

For optimum performance and safety, please read these instructions carefully before connecting, operating or adjusting this product. Please keep this manual for future reference.



Surge Protection Device Recommended

This product contains sensitive electrical components that may be damaged by electrical spikes, surges, electric shock, lightning strikes, etc. Use of surge protection systems is highly recommended in order to protect and extend the life of your equipment.

Contents

Introduction	03
Front Panel Description	04
Rear Panel Description	04
Web-GUI Control - Dashboard	06-09
Web-GUI Control - Network	10
Web-GUI Control - Scheduling	11
Web-GUI Control - Protocols	12-25
Web-GUI Control - Email	26-30
Web-GUI Control - Clock	31
Web-GUI Control - RS-232	32
Web-GUI Control - System	32-34
Web-GUI Control - Security	34-38
Web-GUI Control - Maintenance	39
Web-GUI Control - Sensors	40-45
Specifications	46
Package Contents	46
Maintenance	46
RS-232 Config & Telnet Commands	47-49
Schematic	50
Certifications	51
Installer Notes	52-53

Introduction

The PWR8IEC is an outlet-level metered and switched smart PDU. The unit features 1 x IEC C20 inlet for power (110-250V at up to 16A), 8 x IEC C13 output outlets for supply to high-power consumption devices, and a single non-controlled outlet.

The PDU supports TCP/IP and RS-232 control, with a redundant TCP/IP port as a back-up. Front panel buttons for manual switching of power to individual outlets, and a single mains switch for overall system power.

The PWR8IEC supports advanced power management features including scheduling, sequencing and power consumption. The relay connections (x8) can also be used for automatic control of power to both inlet and individual outlet stages when triggered from 3rd party control platforms or BMS systems. Remote access and monitoring can be set-up and achieved via the web-GUI.

FEATURES:

- Single C20 IEC inlet with 9x C13 IEC outlets (8x controllable outlets + 1x constant outlet)
- Products supports 110-250V AC power input (up to 16A)
- Monitoring and metering of: voltage, current, power, and energy consumption
- Overload protection and interference filtering
- Advanced power management features including scheduling and power on/off sequencing
- Multiformat sensor ports for integration to 3rd party control sensors including temperature, humidity, air pressure, security etc
- Control via TCP/IP, RS-232, front panel buttons, or relays
- Dual TCP/IP network ports providing uninterrupted network service / access with SSL connectivity
- Relays for automated switching of inlet, and individual power outlets
- Provides remote monitoring with password authentication through web-GUI
- Support multiple network and IoT protocols
- 1U design for 19" rack mount integration - rack mounting kit included

Front Panel Description

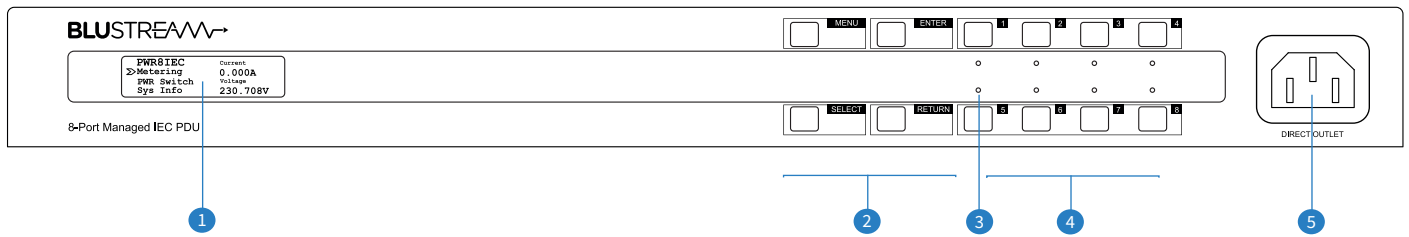

- 1 Screen - Displays menu and status information
- 2 Menu Buttons - Used to navigate the menu on the screen
- 3 Outlet power LED indicator - illuminated when outlet is powered
- 4 Individual outlet power toggle buttons
- 5 C13 IEC Power output - Constant outlet, not controllable

Rear Panel Description

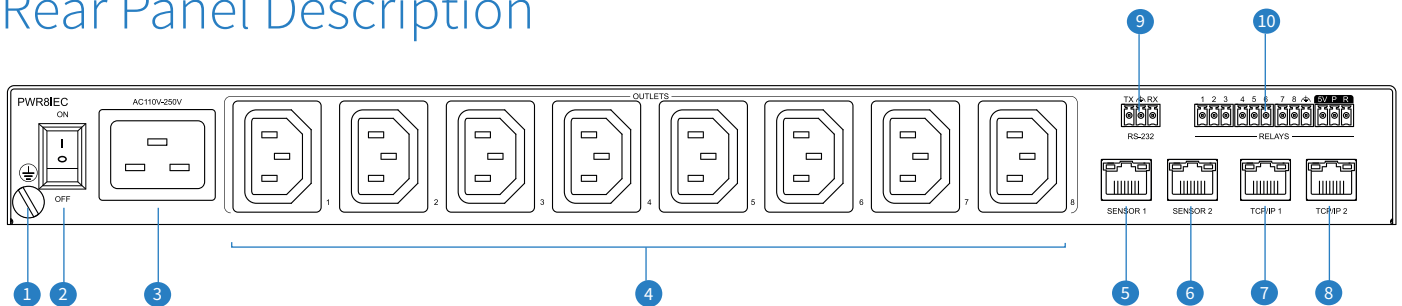

- 1 Ground / earth connection
- 2 Mains power switch
- 3 Mains C20 IEC power inlet
- 4 Individual C13 IEC outlets
- 5 Sensor 1 - Connection to external sensors for monitoring
- 6 Sensor 2 - Connection to external sensors for monitoring
- 7 LAN1 - Main TCP/IP - RJ45 connector for TCP/IP and web-GUI control of the PDU
- 8 LAN2 - Redundant TCP/IP - RJ45 connector for redundant TCP/IP control of the PDU
- 9 RS-232 port - for control of the PDU from a 3rd party control processor or PC (phoenix block included)
- 10 RS-232 port - for control of the PDU from a 3rd party control processor or PC (phoenix block included)

Web-GUI - Initialization and Log In

In order to operate the Web-GUI of the PWR8IEC, you must connect the v/IP RJ45 socket to your local network, or connect directly to the LAN1 port.

By default the unit is set to use DHCP, however if a DHCP server (eg: network router) is not installed, the unit's IP address will revert to the following details:

Default IP Address: **192.168.0.200**

Default Username: **blustream**

Default Password: **@BlS1234**

*** Please note:** New password regulations requires passwords being set for products to be a minimum of 8 characters and contain a minimum of: 1x uppercase letter, 1x lowercase letter, 1x symbol and 1x number. On first login to the user interface, a new password will be required to be set that complies with the above.

Dashboard - Guest Log In

When initially accessing the Web-GUI of the PWR8IEC, the Dashboard page is shown as below. This page shows the current System Status and the Outlet Status displaying: Total Current, Power, Voltage, Consumption and Power Factor and Frequency details. The Outlet Status will define these individual metrics for each device connected to the individual outlet ports.

The control pages can't be accessed without logging in.

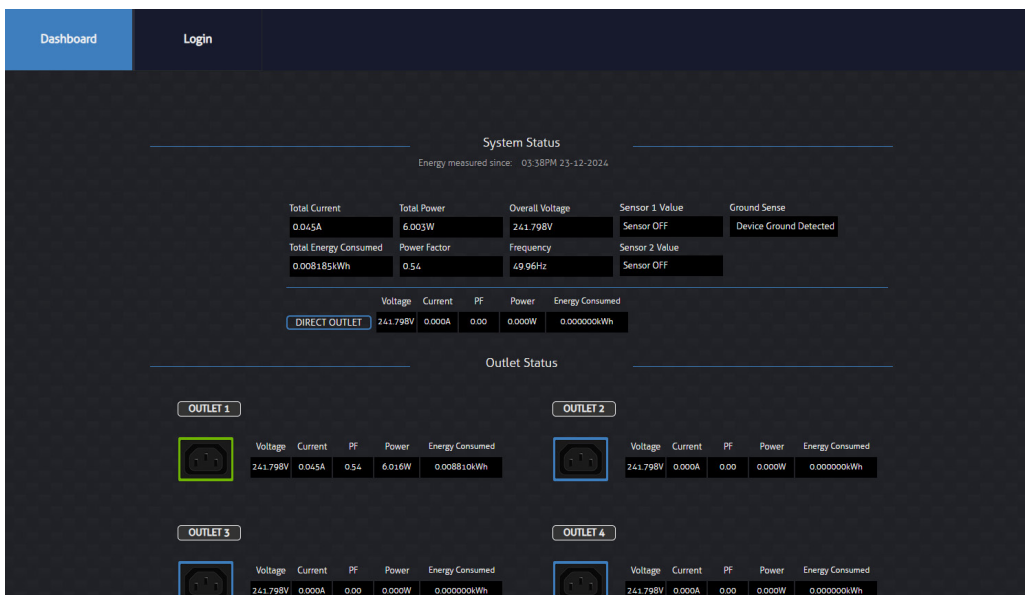

Log In

The Log In page allows for the Administrator to access the system configuration and maintenance area of the Web-GUI. The default log in credentials are noted at the top of this page. The Log In page will also show the current firmware levels running on the PWR8IEC unit.



Password Change

On first login to the PWR8IEC, the default password as noted on the previous page must be updated to a new unique password for the product. The new password must be a minimum of 8 characters in length, and contain a minimum of: 1x uppercase letter, 1x lowercase letter, 1x symbol and 1x number. Please note the new password down, and store in a safe place as the system cannot be accessed without it. A factory reset must be carried out in the event of the Admin password being lost.

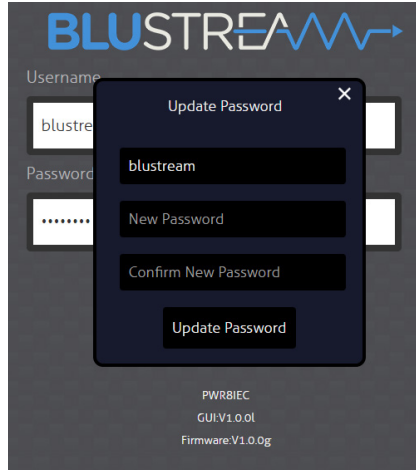

Web-GUI Control - Dashboard

Once logged in as the Administrator, additional control options become available from within the GUI.

The ability to power the unit on and off can be carried out from any page of the user interface using the power button in the bottom right hand corner of the GUI.

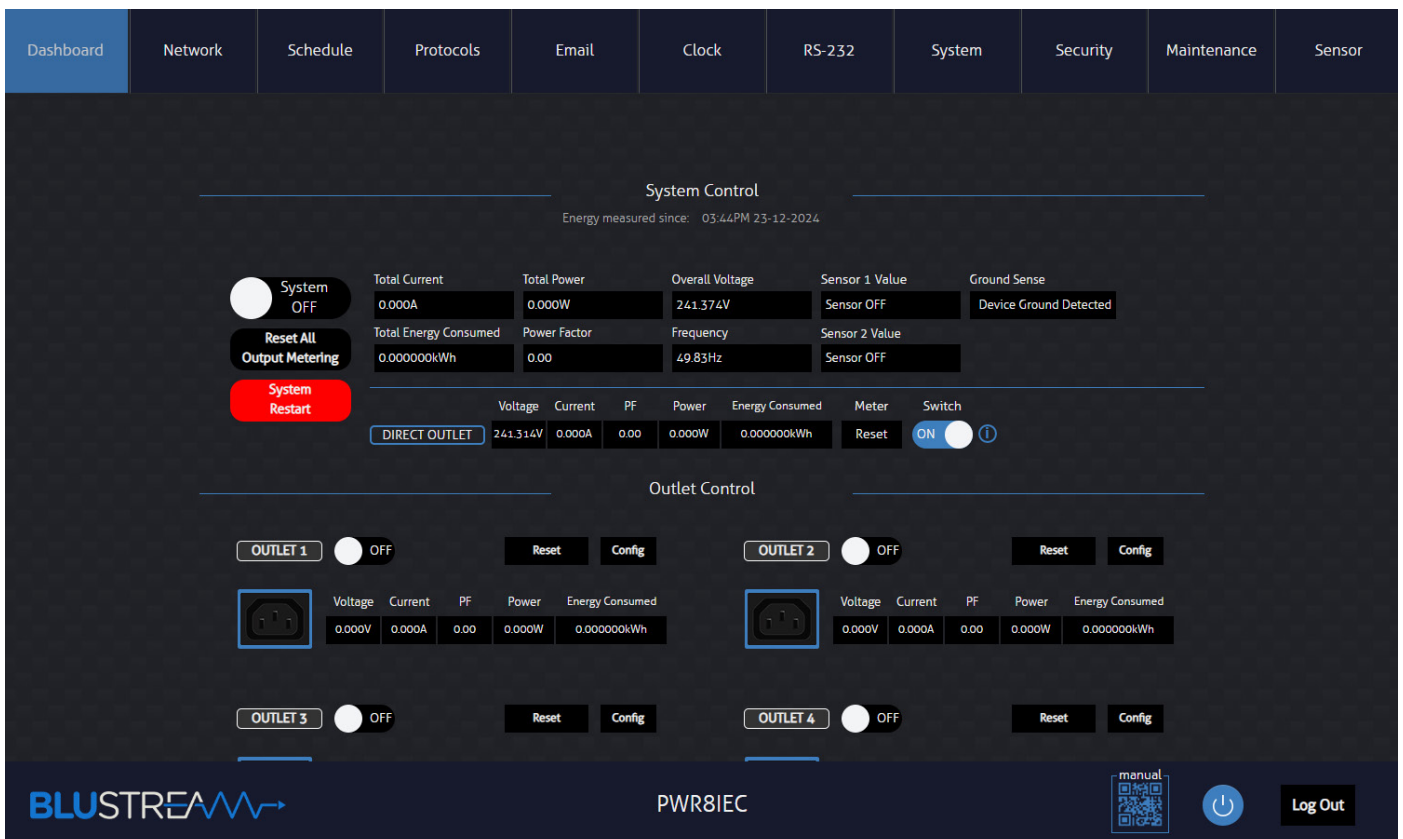

System Control:

- System ON / OFF will toggle power on and off on all outputs, but will not power down the unit.
- Reset All Output Metering will clear the adjacent fields.
- System Restart will cut the power to each output individually (output 1, then 2, then 3, then 4, etc), restarting each output once the power has been cut.
- Ground Sense displays if the PWR8IEC mains detects a proper connection to ground.

Outlet Control:

The individual energy consumption data for each outlet can be found here. Each outlet has a reset and config button.

The Reset button will reset all metering for that corresponding outlet. The duration of the rest is controlled by the Meters Reset Duration option found in the config dialog box.

The Config button allows for the corresponding outlet to be renamed and to have the re-power delay, power off delay and reset duration set.



- Outlet Label Sets the name for the output (max 10 alphanumeric characters)
- Outlet Re-Power Delay Sets the delay for powering on the outlet when triggered
- Outlet Power-Off Delay Sets the delay for powering off the outlet when triggered
- Meters Reset Duration Sets the delay for resetting the Energy Consumed data

Clicking on the IEC connector image gives the user the ability to upload individual customized .png logos (or images) for the device connected to the outlet of the PWR8IEC when in Idle, Connected or Warning states. **Please note:** max file size is 10Kb, and should be no more than 80x80 pixels in size.

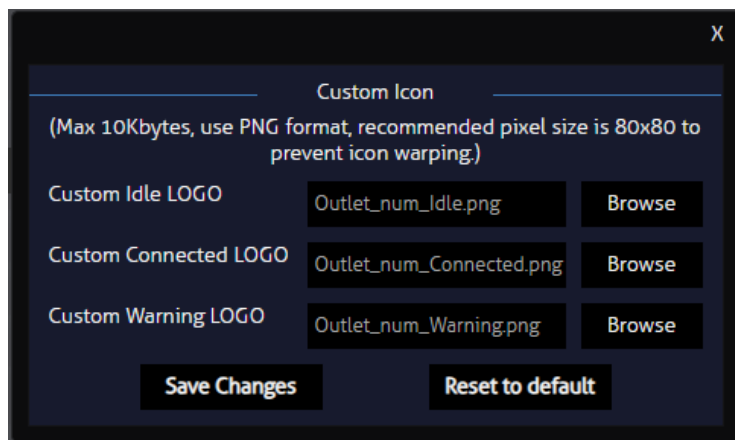

Outlet Control (continued)

Depending on the state of the outlet, the icon for the outlet will be highlighted in a different colour and, depending if you have set custom icons, the icon will change:

- Where an outlet is not drawing any power, the state will be set to idle and the icon will be highlighted blue
- Where a device is connected to an outlet and drawing power, the state will be set to connected and the icon will be highlighted green
- Where a device is connected and an overcurrent has been detected, the state will be set to warning and the icon will be highlighted red



The image displays three screenshots of the PWR8IEC Web-GUI interface, showing the control and monitoring for three different outlets. Each screenshot includes a toggle switch, 'Reset' and 'Config' buttons, an outlet icon, and a table of electrical data.

Outlet Name	State	Voltage	Current	PF	Power	Energy Consumed
Computer	ON	233.323V	0.000A	0.00	0.000W	0.000000kWh
ALTAxBLS	ON	233.474V	0.090A	0.74	15.837W	0.010686kWh
ALTAxBLS	OFF	0.000V	0.000A	0.00	0.000W	0.000000kWh

The PWR8IEC contains additional logic to handle overcurrent on the outlets. This logic can be set on the System page of the Web-GUI and is explained in full detail in that section of the manual.

Outlet Control (continued)

The PWR8IEC features input filtering and is able to detect under voltage and over voltage. If either is detected, all outlets will be put into a warning state and switched off to prevent any damage to the connected devices.

System Control

System: OFF

Buttons: Reset All Output Metering, System Restart

Total Current	Total Power	Overall Voltage
4.623A	1152.390W	251.514V
Total Energy Consumed	Power Factor	Critical: Warning! Overvoltage detected. System voltage is too HIGH, all outlets will be turned OFF.
2.925808kWh	0.99	

Energy measured since: 02:43PM 13-09-2024

Outlet Control

Device	State	Voltage	Current	PF	Power	Energy Consumed
Computer	OFF	0.000V	0.026A	0.41	2.766W	0.373797kWh
Console	OFF	0.000V	0.019A	0.10	0.534W	0.341567kWh
ALTAxBLS	OFF	0.000V	0.009A	0.09	0.220W	0.035924kWh
Machine	OFF	0.000V	4.568A	0.99	1148.873W	2.152634kWh

System Control

System: OFF

Buttons: Reset All Output Metering, System Restart

Total Current	Total Power	Overall Voltage
0.000A	0.000W	182.623V
Total Energy Consumed	Power Factor	Critical: Warning! Undervoltage detected. System voltage is too LOW, all outlets will be turned OFF.
2.898524kWh	0.00	

Energy measured since: 02:32PM 13-09-2024

Outlet Control

Device	State	Voltage	Current	PF	Power	Energy Consumed
Computer	OFF	0.000V	0.000A	0.00	0.000W	0.373570kWh
Console	OFF	0.000V	0.000A	0.00	0.000W	0.341567kWh
ALTAxBLS	OFF	0.000V	0.000A	0.00	0.000W	0.035867kWh
Machine	OFF	0.000V	0.000A	0.00	0.000W	2.125576kWh

Web-GUI Control - Network

The Network tab allows for customizable network configuration of the PWR8IEC for both LAN ports of the unit, IPvX settings, and security functions.

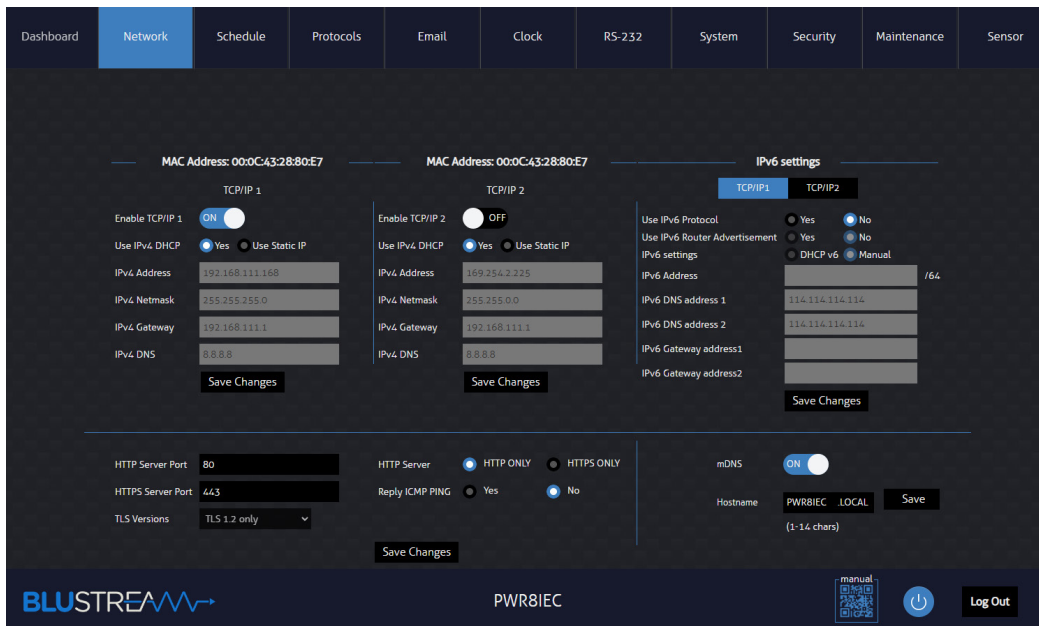

TCP/IP:

Individual settings for the Main (LAN1) and Redundant (LAN2) ports can be configured for TCP/IP control, DHCP or Static IP addressing as required. IPv6 settings are also configurable, updating both LAN connections into an IPv6 addressing connection. A 'Save Changes' button is located at the bottom of each section; please ensure that the relevant button is clicked to update the corresponding section.

HTTP/HTTPS Server:

Secure network connectivity to the Web-GUI can be configured allowing for customized server ports, TLS Versions and whether ICMP Pings are to be replied to.

mDNS:

mDNS is a protocol used in network environments to resolve hostnames to IP addresses within local networks without the need for a dedicated DNS server. The PWR8IEC is able to be accessed via the hostname if the IP address is not known.

This is set to pwr8iec.local by default, but can be changed (if required).

Web-GUI Control - Scheduling

The PWR8IEC contains the ability to configure schedules to suit the needs of an installation. This can be used for power saving, when the equipment is not in use, or as a way to schedule a reboot for devices that may lock up after long periods of inactivity (e.g: satellite receivers).

The scheduling operates over a 24 hour period across a 7 day window. Individual time periods can be set where the product/s attached to the individual outlets (or all outlets) can be powered on and off without the need for a 3rd party control system to issue power commands.

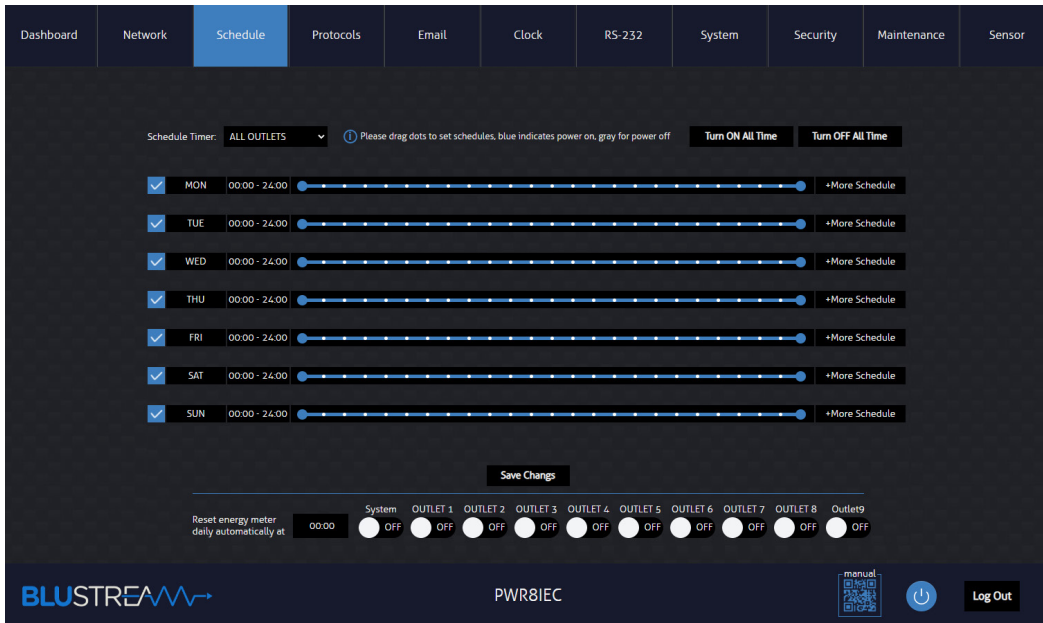

To adjust the logic for any given day, move the blue dots along the timeline to create a highlighted selection: this is when the device will power on. In order to add additional logic (i.e multiple on and off periods), press the + More Schedule button. You can now add additional logic by repeating the steps above.



Alternatively, clicking on the time, next to the day label, will allow for manual time input.

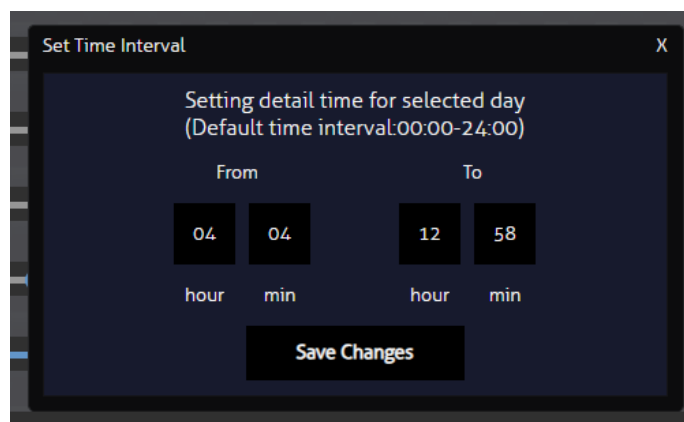

Additionally, the energy meter on the dashboard can be automatically reset at a specified time for a unique selection of outputs. Input a desired time at the bottom of the page and select the output meters to be reset daily at that time.

Once the schedule has been set, use the 'Save Changes' button at the bottom of the page.

*** Please note:** The ALL OUTLETS schedule will override the individual schedules in the event of a conflict.

Web-GUI Control - Protocols

The PWR8IEC has the ability to communicate over multiple different protocols. The ones covered in the Protocols tab are: SNMP, Telnet, MQTT, SSH and Modbus. Each protocol has a sub menu inside the Protocols tab allowing for fine-tuning of these communication methods to the PWR8IEC. See below Web-GUI images of the configuration options:

SNMP - Simple Network Management Protocol:

SNMP is described by a series of Request for Comments (RFCs) that specifies and structures the information that is exchanged between managing and managed systems.

An SNMP agent is a process that runs on a system being managed and maintains the MIB database for the system. An SNMP manager is an application that generates requests for MIB information and processes the responses. The manager and agent communicate using the Simple Network Management Protocol.

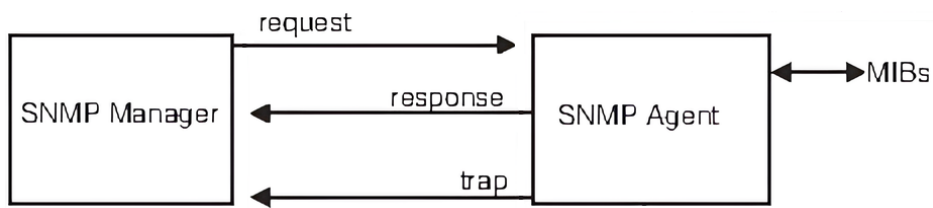

The PWR8IEC acts as an SNMP agent and can be configured to communicate with an SNMP manager of your choice.

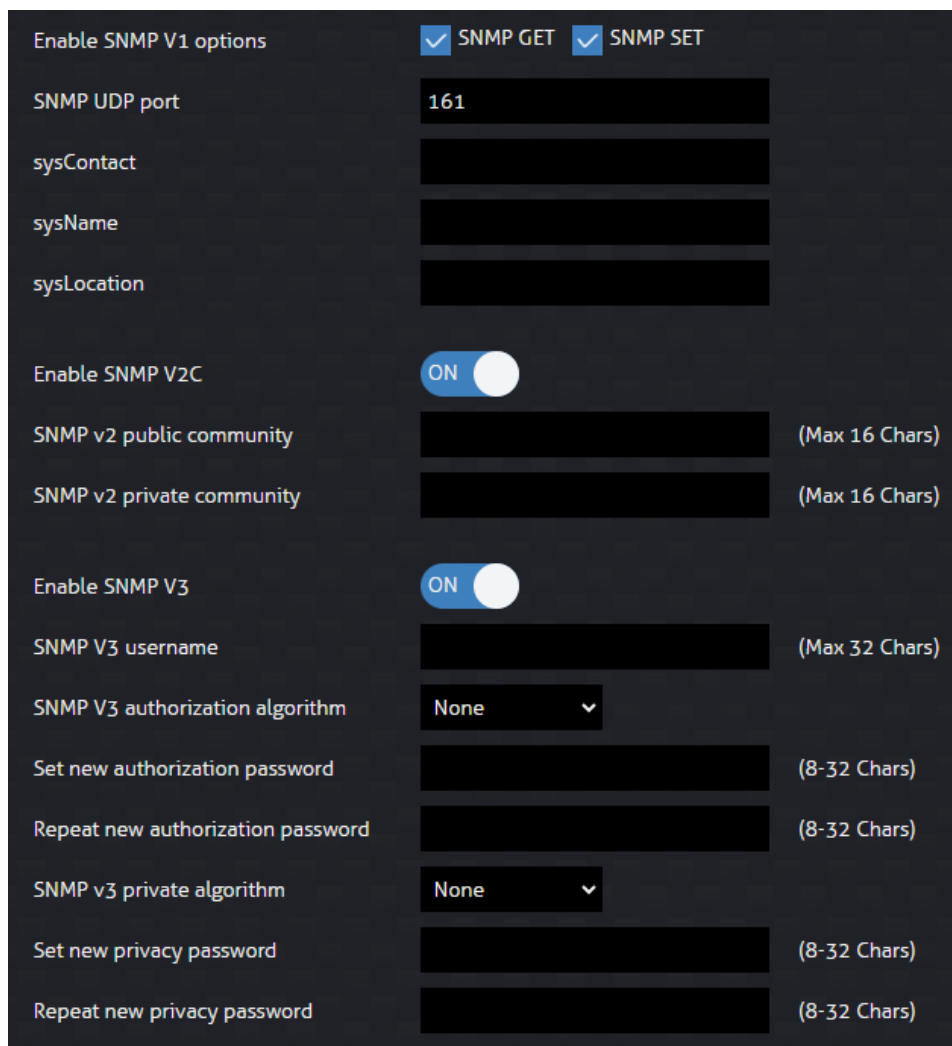

SNMP (continued)

Enable SNMP V1 options

SNMP GET	GET requests will retrieve information from the PWR8IEC's MIB
SNMP SET	SET requests will change information in the PWR8IEC's MIB
SNMP UDP port	SNMP uses UDP port 161 and port 162

sysConact, sysName, and sysLocation can be set to a user defined string (0-255 characters)

Enable SNMP V2C	ON / OFF
SNMP v2 public community	The default read-only community string is commonly set to "public"
SNMP v2 private community	The read-write string is commonly set to "private"

Enable SNMP V3	ON / OFF
SNMP V3 username	up to 32 alphanumeric characters (no spaces)
SNMP v3 authorization algorithm	MD5, SHA1, SHA2-256, SHA-2-384, SHA2-512
Set new authorization password	required when an authorization algorithm has been selected, enter a case sensitive password using alphanumeric characters
SNMP v3 privacy algorithm	DES, AES, AES-128
Set new privacy password	required when a privacy algorithm has been selected enter a case sensitive password using alphanumeric characters

Enable SNMP Trap

An SNMP Trap Receiver captures, displays and logs SNMP Traps. Traps are unrequested notices of events that are sent immediately by the device to the SNMP manager.

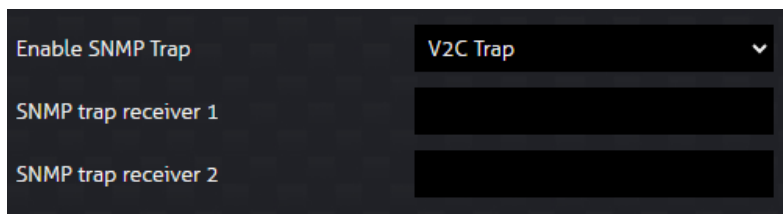
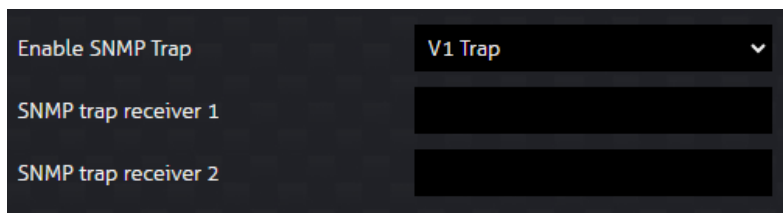

V1 Trap / V2C Trap

SNMP trap receiver 1	The IP address of a trap receiver (V2C & V3 will be populated with this address)
SNMP trap receiver 2	The IP address of an additional trap receiver (V2C & V3 will be populated with this address)

SNMP (continued)

Enable SNMP V1 options	<input checked="" type="checkbox"/> SNMP GET <input checked="" type="checkbox"/> SNMP SET
SNMP UDP port	161
sysContact	test_sysContact
sysName	test_sysName
sysLocation	test_sysLocation
Enable SNMP V2C	<input checked="" type="checkbox"/>
SNMP v2 public community	public (Max 16 Chars)
SNMP v2 private community	private (Max 16 Chars)
Enable SNMP V3	<input checked="" type="checkbox"/>
SNMP V3 username	test (Max 32 Chars)
SNMP V3 authorization algorithm	MD5
Set new authorization password (8-32 Chars)
Repeat new authorization password (8-32 Chars)
SNMP v3 private algorithm	DES
Set new privacy password (8-32 Chars)
Repeat new privacy password (8-32 Chars)
Enable SNMP Trap	V1 Trap
SNMP trap receiver 1	10.0.0.63
SNMP trap receiver 2	

- Open the snmpb software and navigate to Options/Manage Agent Profiles... and create a new user. Set the Agent Address to the IP address of the PWR8IEC and the port to the SNMP UDP port set in the Web-GUI.

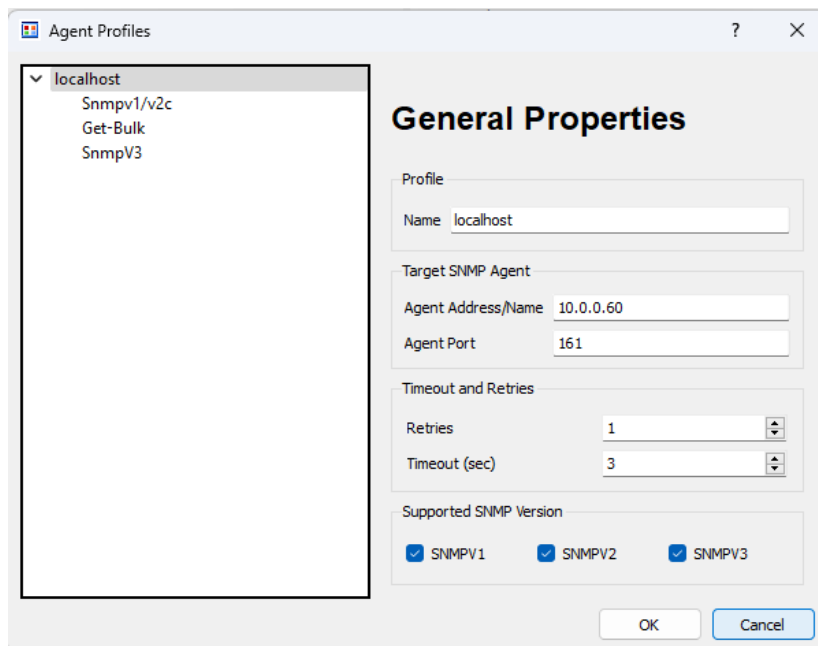

SNMP (continued)

3. Set the Snmpv1/v2c public and private communities to SNMP v2 public and private communities set in the Web-GUI.

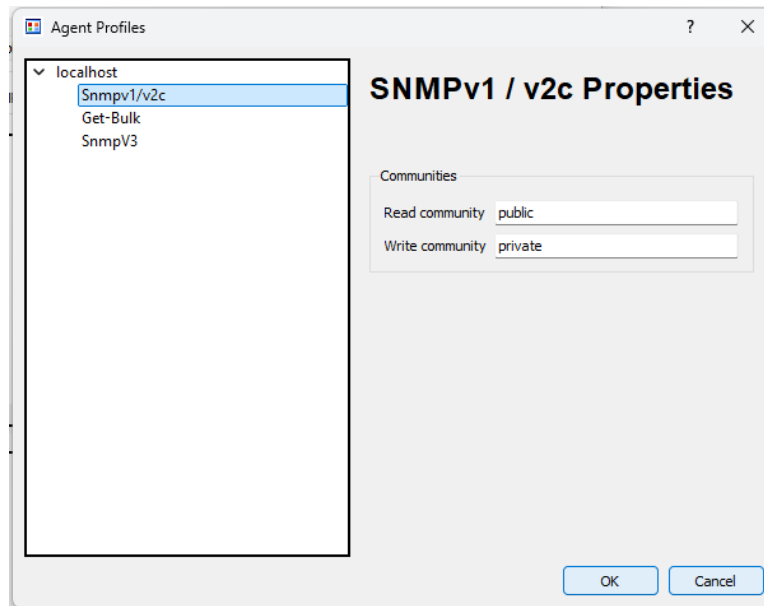

4. Navigate to Options/Manage SNMPv3 USM Profiles... and fill in the fields to match what was set under SNMP V3 in the Web-GUI.

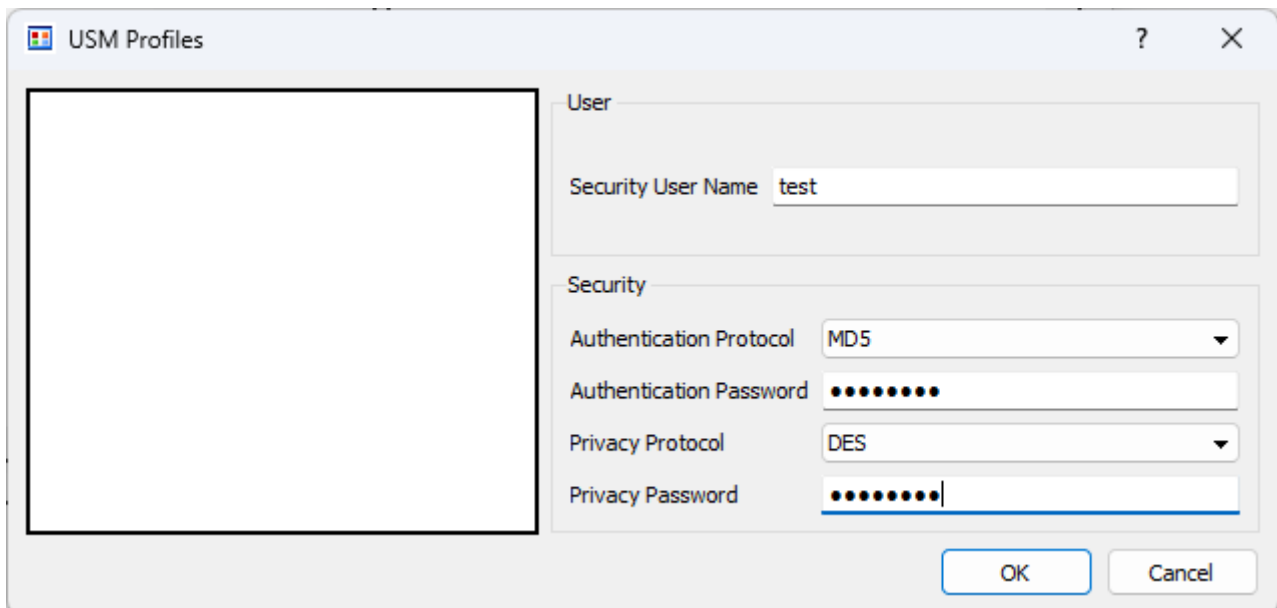

5. You can now verify if the software can communicate with the PWR8IEC.

On the main screen, with SNMPv1 selected, navigate through the MIB tree to find the system folder:

- iso
 - org
 - dod
 - internet
 - mgmt
 - mib-2

SNMP (continued)

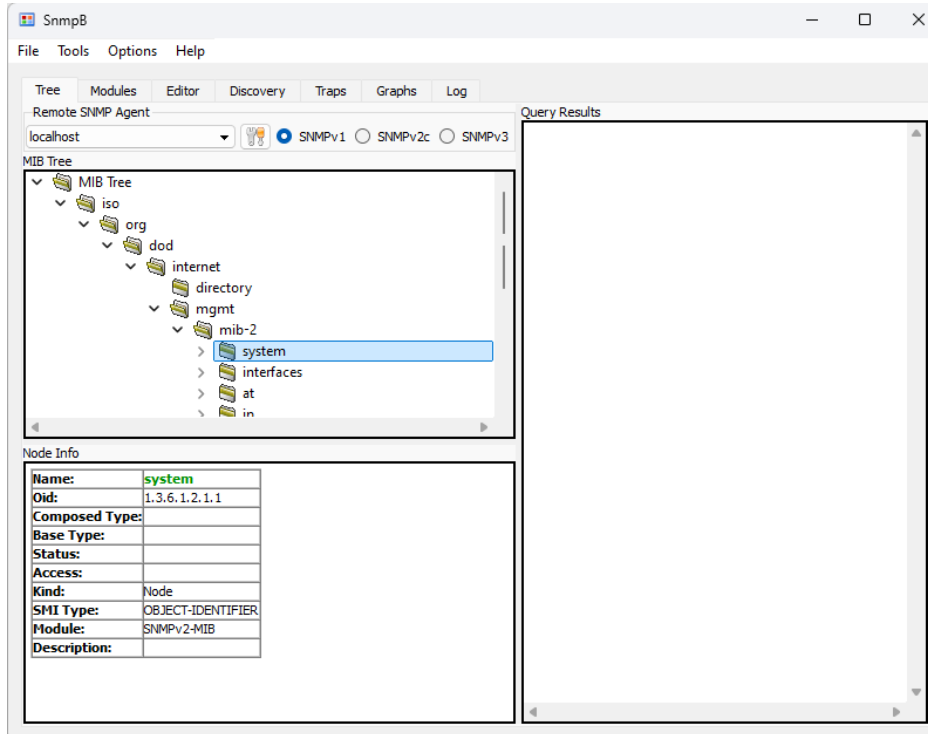

6. Right click on system and press 'Walk'.

Under Query Results, look for the custom labels set for sysContact, sysName, sysLocation in the Web-GUI.

If they appear with the correct labels, then the SNMP protocol is working.

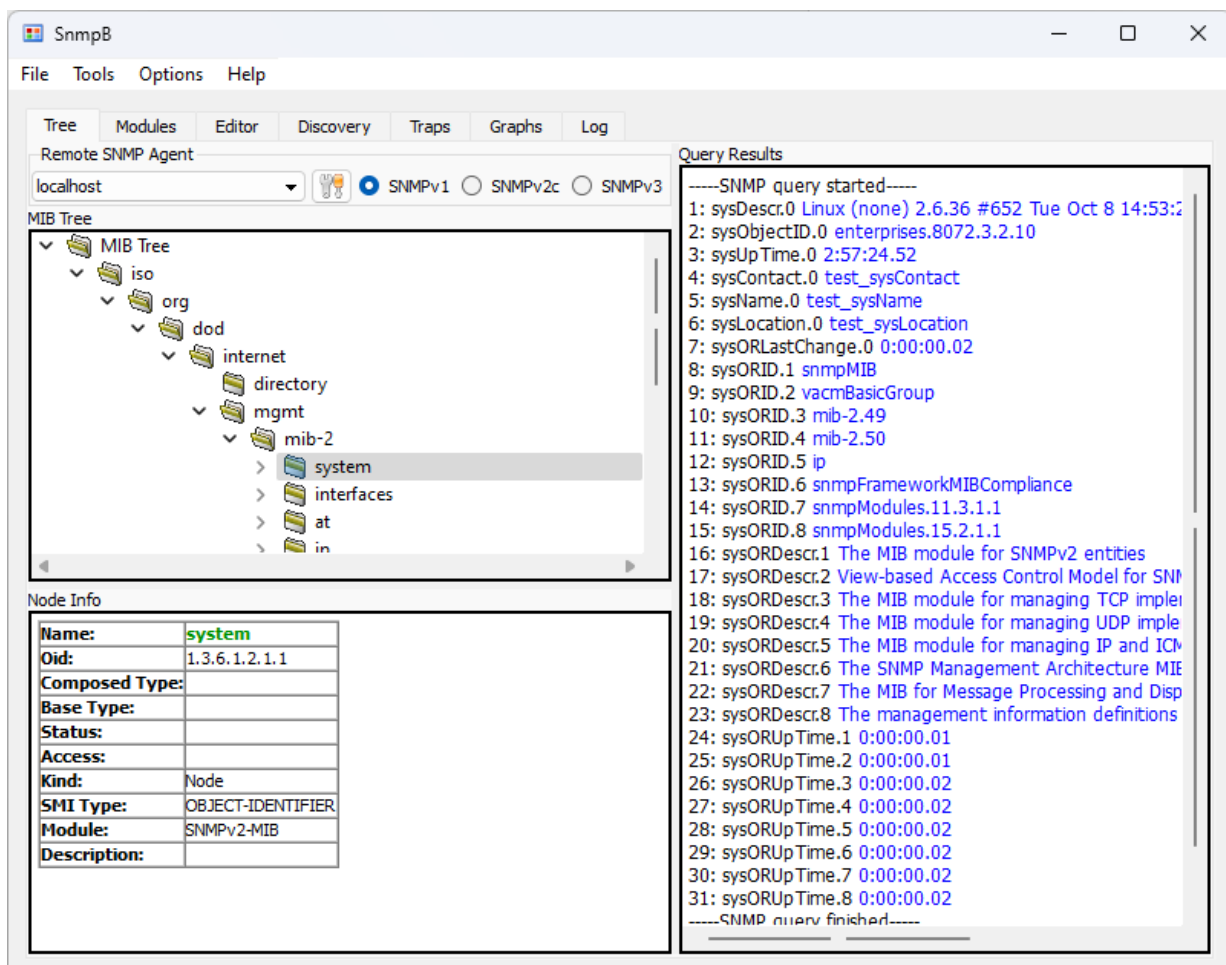

Telnet

Telnet (telecommunications network) is a client/server application protocol that provides access to virtual terminals of remote systems on local area networks or the Internet.



Telnet (continued)

- Enable Telnet ON / OFF
- Telnet TCP port default port number is 23
- Raw mode in this mode, lines ending the ASCII NUL character, and no control codes are present. In general, you will use telnet mode if you're communicating with a standard telnet compatible client, and raw mode if you're communicating through a custom script or application.
- Active negotiation The telnet-negotiated setting determines if the Transport Layer Security (TLS) negotiation between the client and the server is done on the established telnet connection or on a TLS connection prior to the Telnet negotiations
- Activate echo used to display text on the terminal or console
- Push messages send notifications when logging in
- Delay after 3 failed logins if enabled, the connection will close after 3 failed login attempts
- Require Login (Telnet)
- Use password Local stored password; set a local username and password
RADIUS Server password; use stored RADIUS username and password (set under Security tab)

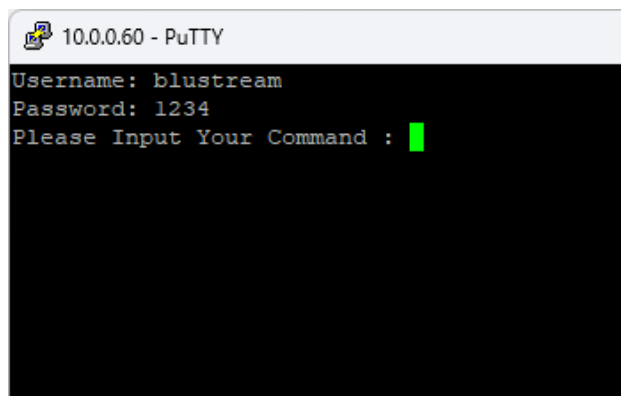

MQTT - Message Queuing Telemetry Transport:

MQTT is a lightweight, publish-subscribe, machine to machine network protocol for message queue/message queuing service.

The MQTT protocol defines two types of network entities: a message broker and a number of clients:

An MQTT broker is the back end system which coordinates messages between the different clients.

An MQTT client is any device that runs an MQTT library and connects to an MQTT broker over a network.

Clients and brokers begin communicating by using an MQTT connection. Clients initiate the connection by sending a CONNECT message to the MQTT broker. The broker confirms that a connection has been established by responding with a CONNACK message. Both the MQTT client and the broker require a TCP/IP stack to communicate. Clients never connect with each other, only with the broker.

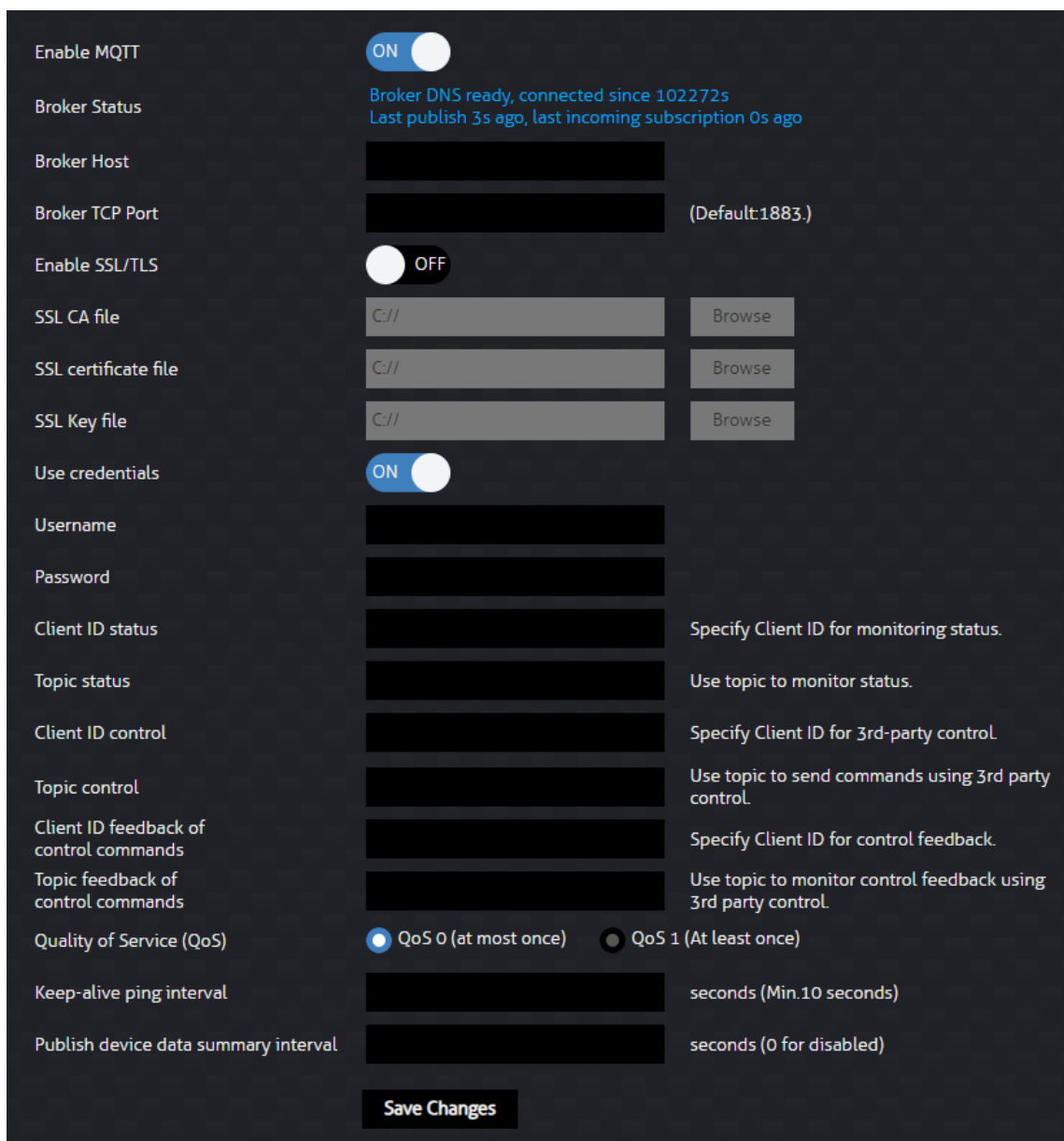

The image shows a configuration interface for MQTT. It features a dark background with white text and controls. At the top, there is a toggle switch for 'Enable MQTT' which is turned 'ON'. Below this, the 'Broker Status' is shown as 'Broker DNS ready, connected since 102272s' and 'Last publish 3s ago, last incoming subscription 0s ago'. The 'Broker Host' and 'Broker TCP Port' (default 1883) are input fields. There are three 'Browse' buttons for 'SSL CA file', 'SSL certificate file', and 'SSL Key file', all currently showing 'C://'. The 'Use credentials' toggle is also 'ON'. Below are input fields for 'Username', 'Password', 'Client ID status', 'Topic status', 'Client ID control', 'Topic control', 'Client ID feedback of control commands', and 'Topic feedback of control commands'. The 'Quality of Service (QoS)' is set to 'QoS 0 (at most once)'. The 'Keep-alive ping interval' is set to 'seconds (Min.10 seconds)' and the 'Publish device data summary interval' is set to 'seconds (0 for disabled)'. A 'Save Changes' button is at the bottom.

MQTT (continued)

Enable MQTT	ON / OFF
Broker Status	Displays current information about the broker
Broker Host	Broker host address
Broker TCP Port	TCP/IP port 1883 & 8883 are reserved for use with MQTT. Managed hosts may use their own port
Enable SSL/TLS	Upload SSL/TLS files for MQTT secure connections
- SSL CA file	
- SSL certificate file	
- SSL key file	

Create Log In Credentials:

Username

Password

Client ID

- Client IDs identify a connection from a specific device or client to an MQTT broker

Topics

- Topics are keywords that the MQTT broker uses to filter messages for the MQTT clients. Topics are organised in a hierarchy, akin to a folder or directory. For example, a broker may organise topics as:
 - home/groundfloor/livingroom/light | home/firstfloor/kitchen/temperature
- When a publisher has a new item of data to distribute, it sends a control message with the data to the connected broker. The broker then distributes the information to any clients that have subscribed to that topic.

Quality of Service (QoS)

- Quality of Service (QoS) in MQTT messaging is an agreement between sender and receiver on the guarantee of delivering a message. The PWR8IEC can choose between two levels of QoS:
 - QoS Level 0
 - The client simply publishes the message, and there is no acknowledgement by the broker (no response is required).
 - QoS Level 1
 - The broker sends an acknowledgement back to the sender once the message is received; in the event that the acknowledgement is lost, the sender will realise the message hasn't got through and will send the message again. The client will re-send until it gets the broker's acknowledgement. This means that sending is guaranteed, although the message may reach the broker more than once.

Keep -alive ping interval

- Keep Alive is a feature of the MQTT protocol that allows an MQTT client to maintain its connection with a broker by sending regular control packets to the broker. The MQTT client is responsible for setting an appropriate keep-alive interval, for example: basing it on it's current signal strength, optimizing the connection for it's specific circumstances.
- The maximum interval is 18h 12m 15s
- The minimum interval is 0s, effectively deactivating the mechanism

Publish device summary data interval

- Interval the PWR8IEC will publish it's data

MQTT (continued)

An MQTT setup example has been provided on the following pages:

In this example, we will be using the MQTTX software and HiveMQ, a free public MQTT broker.

1. Setup the MQTT tab with a username, password, and topic IDs:

Enable MQTT	<input checked="" type="checkbox"/> ON	
Broker Status	Broker DNS ready, connected since 28990s Last publish 8s ago, last incoming subscription 1131216s ago	
Broker Host	broker.hivemq.com	
Broker TCP Port	1883	(Default:1883.)
Enable SSL/TLS	<input type="checkbox"/> OFF	
SSL CA file	C://	Browse
SSL certificate file	C://	Browse
SSL Key file	C://	Browse
Use credentials	<input checked="" type="checkbox"/> ON	
Username	admin	
Password	
Client ID for PWR4IEC status	statusid	Specify Client ID for monitoring status.
Topic for PWR4IEC status	pwr4iecstring	Use topic to monitor status of the PWR4IEC.
Client ID for PWR4IEC control	controlid	Specify Client ID for 3rd-party control.
Topic for PWR4IEC control	pwr4iecccontrol	Use topic to send commands to the PWR4IEC using 3rd party control.
Client ID for PWR4IEC feedback of control commands	feedbackid	Specify Client ID for control feedback.
Topic for PWR4IEC feedback of control commands	pwr4iecfceedback	Use topic to monitor control feedback from the PWR4IEC using 3rd party control.
Quality of Service (QoS)	<input checked="" type="radio"/> QoS 0 (at most once) <input type="radio"/> QoS 1 (At least once)	
Keep-alive ping interval	60	seconds (Min.10 seconds)
Publish device data summary interval	10	seconds (0 for disabled)

2. Open the MQTTX software and setup a new connection to the HiveMQ broker

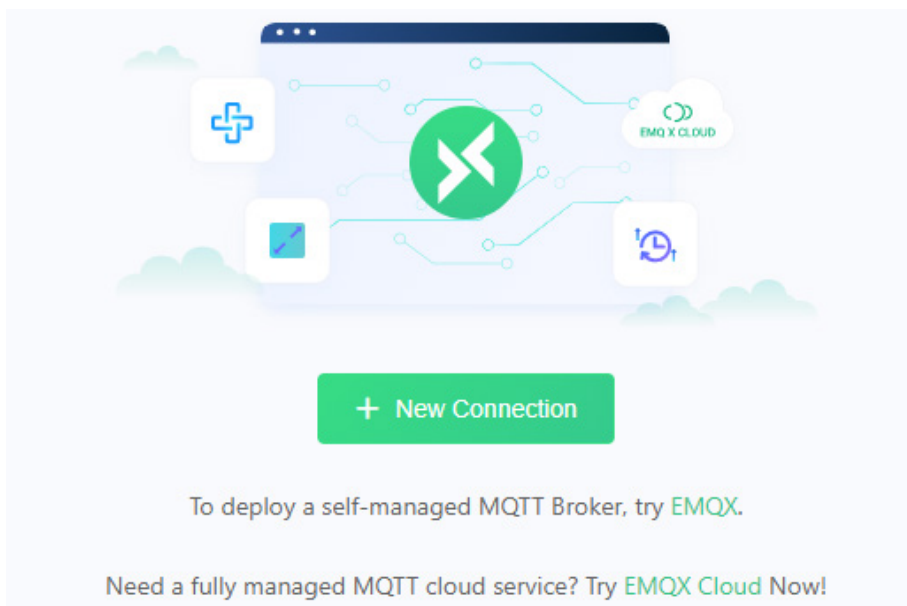

MQTT (continued)

- 3. Fill in the appropriate fields from the PWR8IEC settings:
- 4. Click connect and once connected, create a new subscription
- 5. Enter the topic that you want to subscribe to; we have three topics:

Topic Status

- Generates the product status

Topic Control

- Sends API commands to control the PWR8IEC

Topic Feedback

- This will send [Success] feedback per API command sent

General

* Name

* Host

* Port

Client ID

Username

Password

SSL/TLS

In this example, we will subscribe to the PWR8IEC status update

Enter the Client ID status that was set in the Web-GUI

- 6. If successful, the PWR8IEC status line will start publishing data

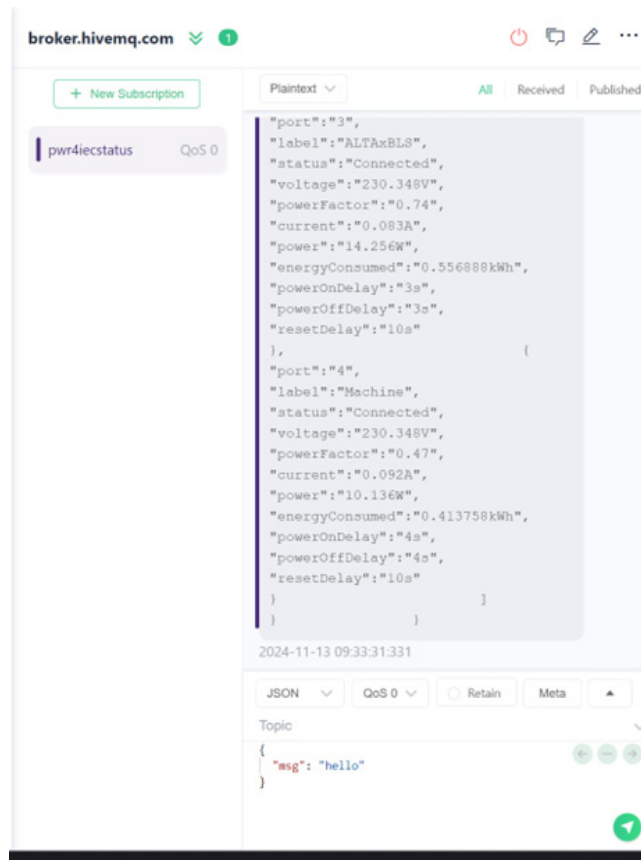

*** Please note:** Not all APIs are available for MQTT control. At the moment we are limited to one line of feedback, therefore control options are mainly intended for outlet settings. Controls which apply network changes, resets, or reboots are not available for MQTT control as this could break communication and compromise functionality. The APIs can be found at the back of manual.

SSH - Secure Shell Protocol:

The Secure Shell (SSH) protocol is a method for securely sending commands to a computer over an unsecured network. SSH uses cryptography to authenticate and encrypt connections between devices.

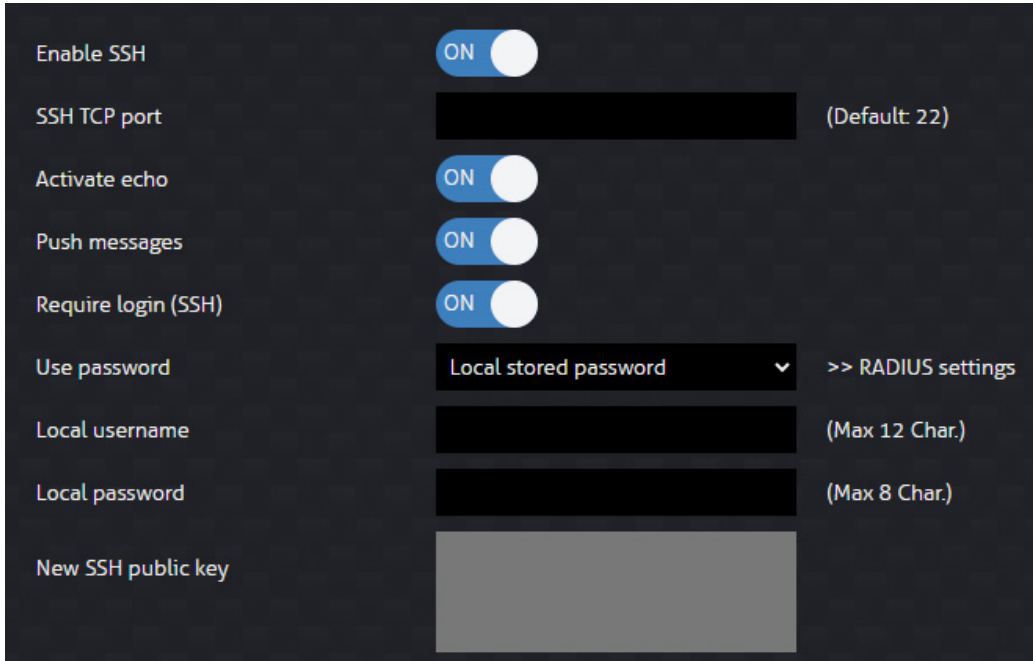

- Enable SSH ON / OFF
- SSH TCP Port default port number is 22
- Activate echo set text to be displayed on the terminal or console
- Push messages send log in notifications
- Require log in (SSH)
- Use password The PWR8IEC can utilise SSH with a locally stored password or with a RADIUS setup
 - To use a locally stored password, select 'Local stored password' from the drop down, enter a local username and password and Save changes (New SSH public key field will be disabled)
 - You can then connect using your terminal of choice to the IP address of the unit with the local credentials that were set:

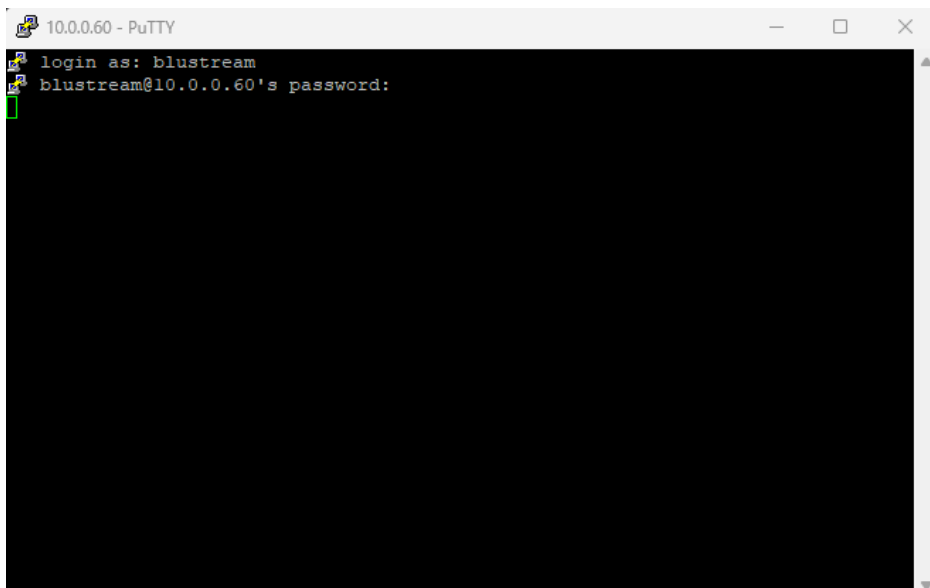

SSH (continued)

- To use a RADIUS setup, select 'RADIUS server password' from the drop down (Local username and Local password fields will be disabled)
- After generating your own public/private key pair, paste the public key into the 'New SSH public key' field
- Log in using your terminal of choice to send commands and received feedback

* **Please note:** When generating a public/private key pair, use .ppk file version 2. RADIUS set up is covered in full detail in the Security section of this manual.

Modbus

Modbus TCP/IP is an industrial communication protocol that extends the traditional Modbus protocol to Ethernet networks using the TCP/IP suite. It allows Modbus-compatible devices to communicate efficiently over modern IP-based networks.

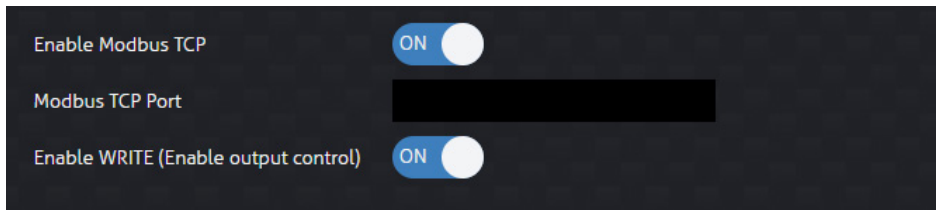

- Enable Modbus TCP ON / OFF
- Modbus TCP Port default port number is 502
- Enable WRITE Enables writing on the Modbus registers of the transmitter and devices connected to it

* **Please note:** Only enable WRITE when you need to write on the Modbus registers. Disable WRITE when you don't need to write anymore. Do not enable WRITE in an open network

A Modbus setup example has been provided on the following pages:

In this example, we will be using the Modbus Poll software.

1. Open the Modbus Poll software
2. Under Setup, Read/Write Definition..., Set Quantity to 40 and Scan Rate to 5000

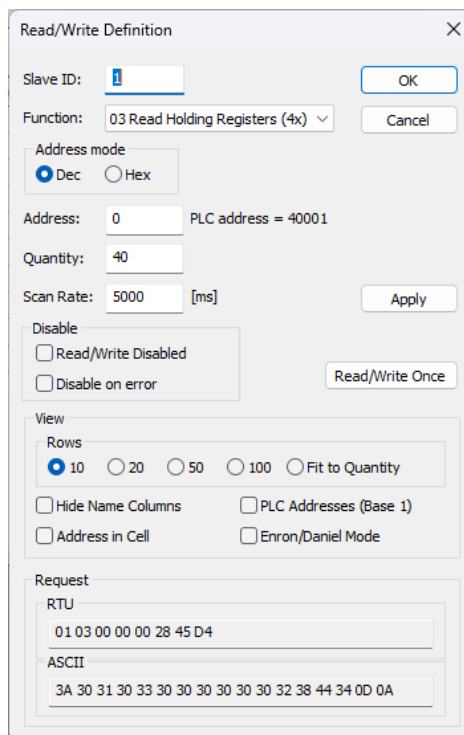

Modbus (continued)

- Under Connection, Connect..., Set the IP Address to that of the PWR8IEC's, set the server port to the Modbus TCP Port set in the Web-GUI and set the Connect Timeout to 5000

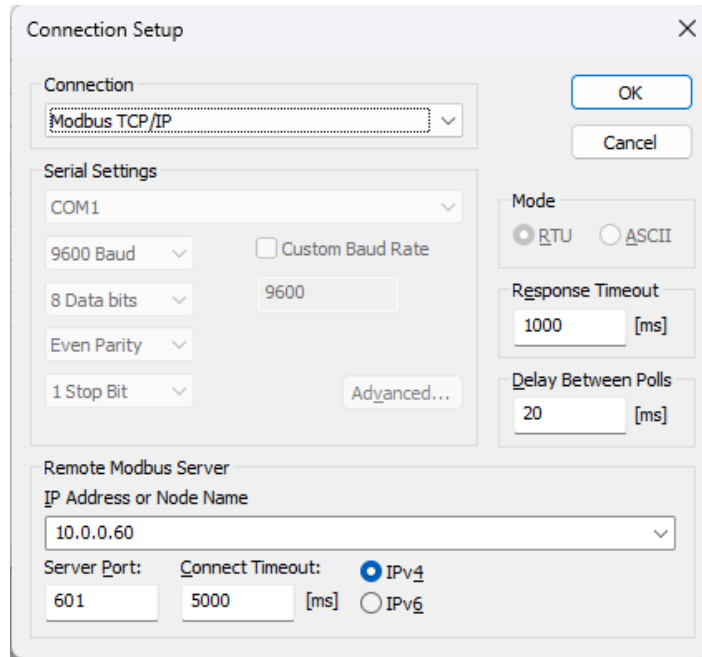

- Once the connection is established, data will start being received into the table. This corresponds to data of each outlet as shown below

Mbpoll1

Tx = 94: Err = 7: ID = 1: F = 03: SR = 5000ms

	Name	00000	Name	00010	Name	00020	Name	00030
0		230		0		0		0
1		564		0		0		725
2		230		0		10		0
3		564		0		310		0
4		230		0		0		0
5		564		91		0		0
6		230		0		0		0
7		564		0		0		0
8		0		0		0		0
9		0		0		70		480

ALTAxBS ON Reset Config

Voltage	Current	PF	Power	Energy Consumed
230.564V	0.000A	0.00	0.000W	0.000000kWh

Machine ON Reset Config

Voltage	Current	PF	Power	Energy Consumed
230.564V	0.000A	0.00	0.000W	0.000000kWh

ALTAxBS ON Reset Config

Voltage	Current	PF	Power	Energy Consumed
230.564V	0.000A	0.00	0.000W	0.070769kWh

Machine ON Reset Config

Voltage	Current	PF	Power	Energy Consumed
230.564V	0.091A	0.48	10.310W	0.725597kWh

Web-GUI Control - Email

The PWR8IEC is capable of generating and sending emails when an outlet enters a warning state (i.e. when a device is not pulling power outside of any scheduled downtime, power outages, or power surges). The email can be customized with unique topic headers, and content can be customized to include individual outlet statuses, and then tested from this page. Emails can also be generated as a daily report by checking the box in SMTP Settings.

SMTP Settings must be configured for emails to be generated.

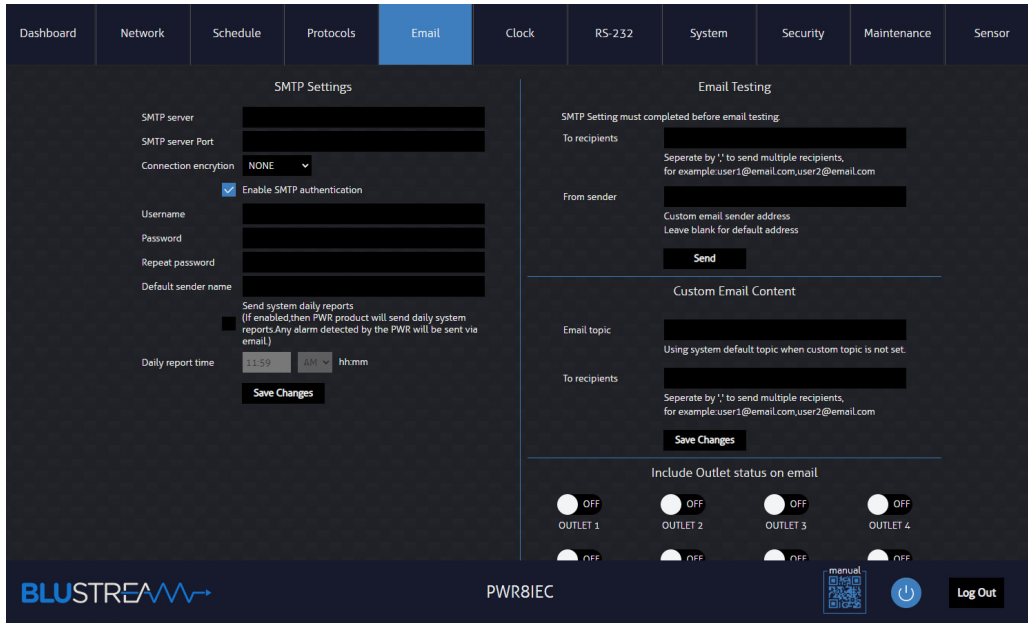

SMTP:

SMTP (Simple Mail Transfer Protocol) is a communication protocol used for sending and receiving email messages over the Internet. Mail servers and other message transfer agents use SMTP to send, receive and relay mail messages.

- SMTP server: server address of SMTP host
- SMTP server port: ensure correct port is set for specified host
- Connection encryption: None / SSL/TLS / STARTTLS
- Enable SMTP authentication: log in using the authentication method provided by the server
- Username: enter username
- Password: enter password
- Default sender name: email address that will be displayed as sender
- Send system daily reports: Daily system reports will include the statuses of the outlets selected in 'Include Outlet Status on Email'.
- Daily report time: specify at which time the daily report will be sent (clock tab should be set)

An example of SMTP server set up using gmail has been provided on the following pages:

You can set up a free Google account and configure it to act as a SMTP server to send report emails from the PWR8IEC.

SMTP (continued)

- 1. Log into your Google account and go to Security.

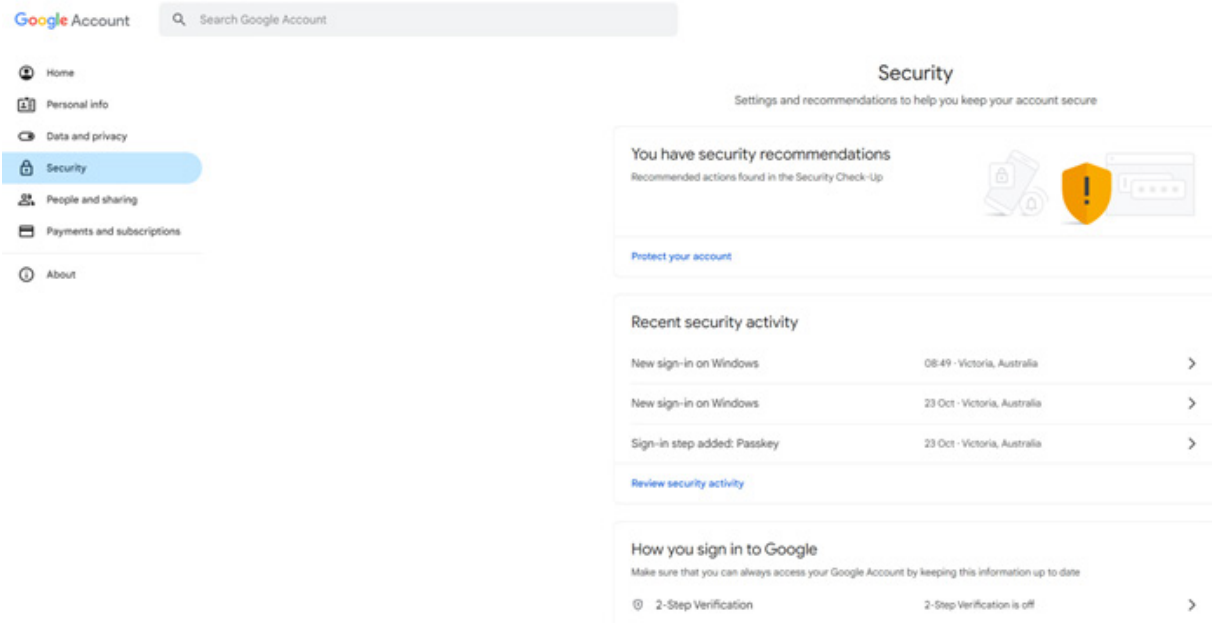

* Please note: Ensure 2-Step verification is enabled as this is required for this feature to function as intended.

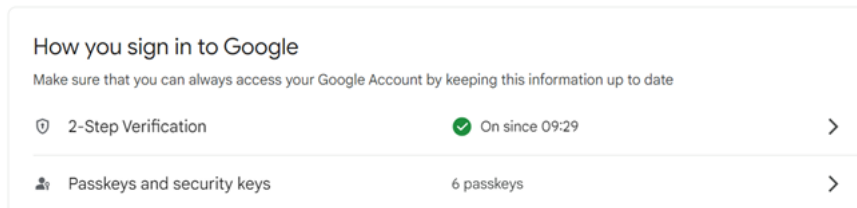

- 2. In the Security tab, use the search bar to find "App passwords".

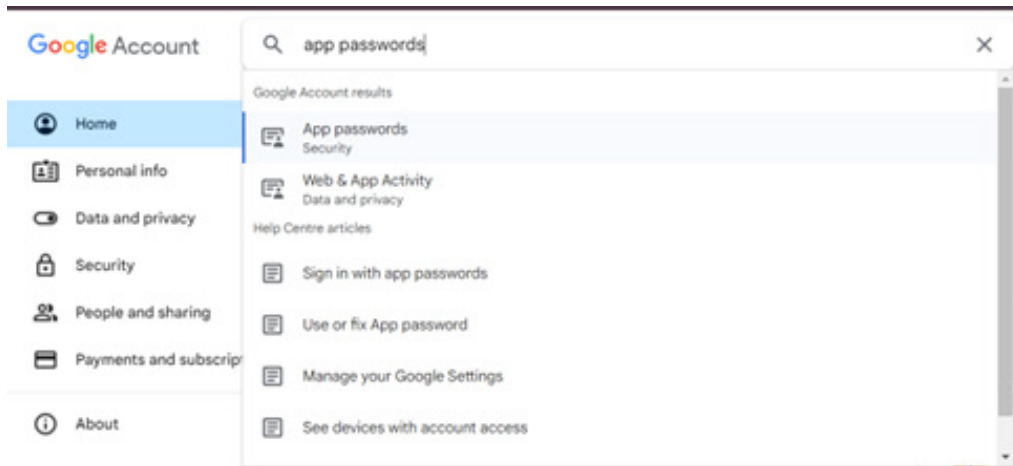

SMTP (continued)

3. Create an app by clicking the box titled "App name".

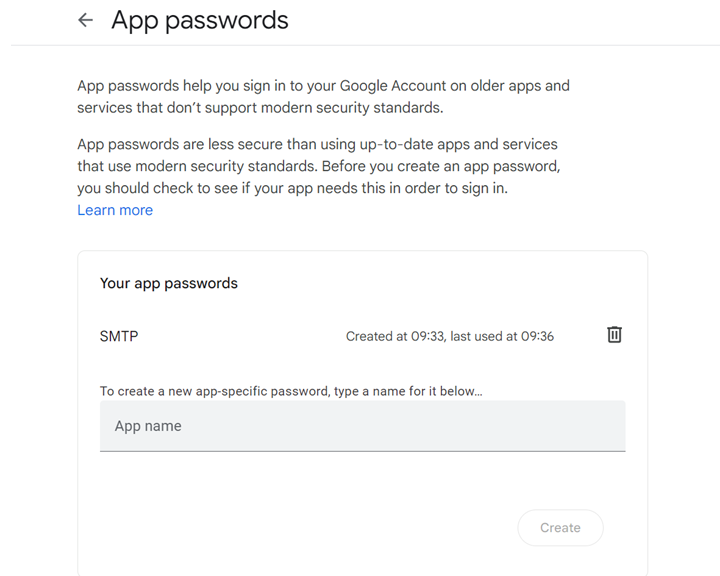

4. Enter an app name and click create.

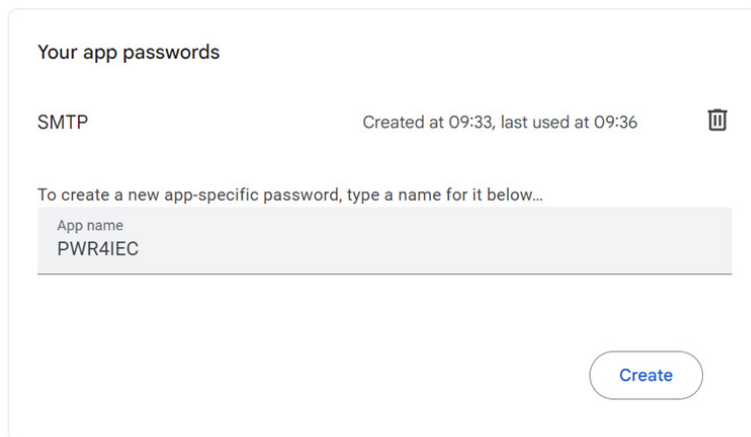

This generates a password as shown below. Record this password in a safe place as you'll have to repeat these steps if you lose it.

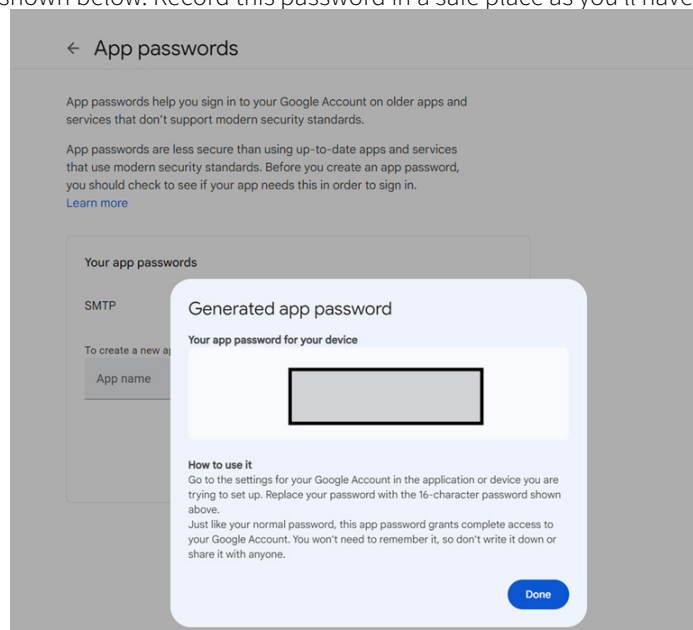

SMTP (continued)

5. Use the generated credentials to fill in the SMTP Settings in the PWR8IEC’s Web-GUI.

The screenshot shows the 'SMTP Settings' configuration page. It includes fields for SMTP server (smtp.gmail.com), SMTP server Port (465), Connection encryption (SSL/TLS), a checked checkbox for 'Enable SMTP authentication', Username (Email address of account used for SMTP), Password (Password as generated by App), Repeat password (Password as generated by App), and Default sender name (Email address that will appear as sender).

To validate the email functionality, we will use the email testing section on the Web-GUI.

The screenshot shows the 'Email Testing' configuration page. It includes a message 'SMTP Setting must completed before email testing.', a 'To recipients' field (sample@gmail.com), and a 'From sender' field (sample@gmail.com). Instructions for recipients and sender fields are provided.

You can set custom email topics and choose recipients through the below settings.

If no topic is defined, the default topic “Machine status email for PWR8IEC” will be used.

The screenshot shows the 'Custom Email Content' configuration page. It includes an 'Email topic' field (PWR8IEC Updates) and a 'To recipients' field. A 'Save Changes' button is visible at the bottom.

Outlets can be configured to be included or excluded from email reports. By default, every outlet is set to ON.

The screenshot shows the 'Include Outlet status on email' configuration page. It features four toggle switches, all of which are turned ON, labeled 'Computer', 'Console', 'ALTAxBLS', and 'Machine'.

SMTP (continued)

An example warning email with the default topic is shown below:

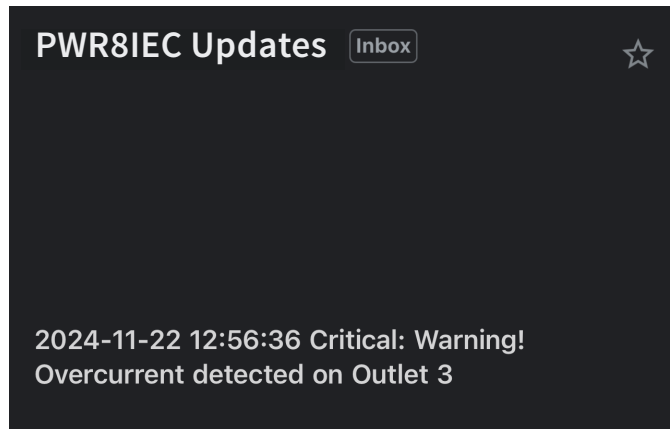

An example daily log email with the default topic is shown below. The logs for each output are attached:

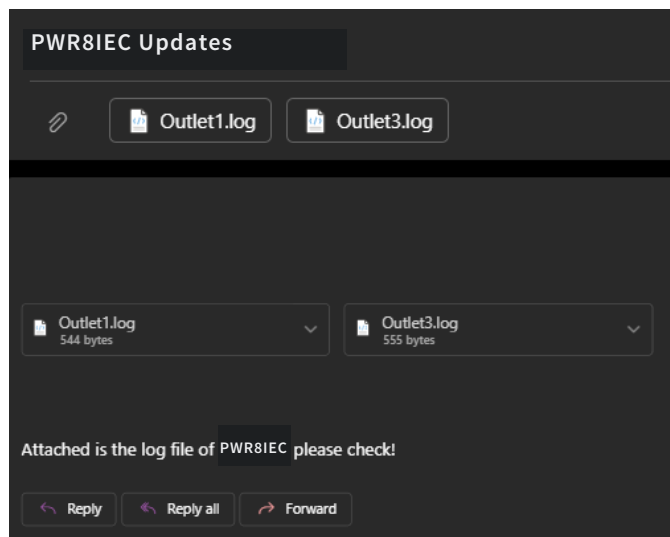

Web-GUI Control - Clock

For warning alerts, scheduling and other daily functions to work as intended, the internal clock of the PWR8IEC must be set accurately. This may be done manually, or taken from an NTP server. The PWR8IEC contains an internal battery for times where the unit may not be powered directly, or during a mains power outage, to keep the clock in sync.

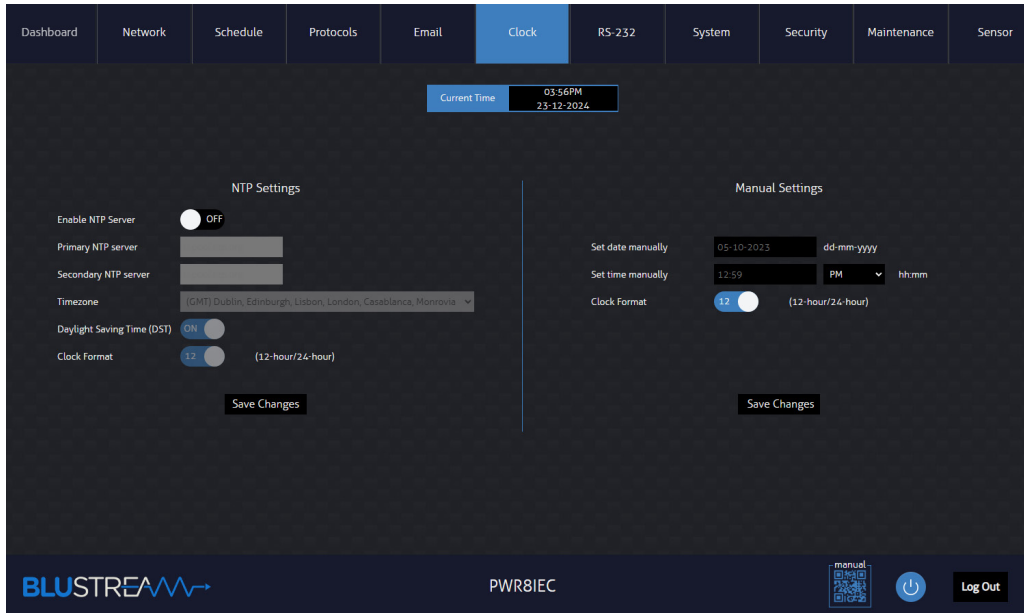

NTP (Network Time Protocol) Settings:

Enable NTP Server	Enable Manual Settings / Disable NTP Settings
Primary NTP Server	Set the Primary NTP Server Address
Secondary NTP Server	Set the Secondary NTP Server Address
Timezone	Set the Timezone offset
Daylight Saving Time (DST)	ON / OFF (DST must be set manually)
Clock Format	12 Hour / 24 Hour

*** Please note:** NTP servers operate in UTC (Universal Coordinated Time) so DST must be set manually according to your locale. Ensure the PWR8IEC can access the internet through the LAN ports for NTP functionality.

Manual Settings:

*** Please note:** In order to change Manual Settings, 'Enable NTP Server' under NTP Settings must be turned off.

Set Date Manually	Enter the date (dd-mm-yyyy)
Set Time Manually	Enter the time (hh:mm)
Clock Format	12 Hour / 24 Hour

Web-GUI Control - RS-232

The PWR8IEC is able to be controlled via the RS-232 port on the back on the unit. The APIs can be found at the back of this manual.

The PWR8IEC is also able to send commands via the TX pin on the RS-232 port to other 3rd party products.

The RS-232 page allows for a test command to be sent to a linked product connected to the RS-232 port to test if serial communication is working as intended.

Communication parameters such as character set (ASCII or HEX), baud rate, command termination (LF, CR, or both), and parity can be configured for integration with a third-party control system.

Once confirmed, you can proceed to integrate this with a third-party control system and issue commands to external products.

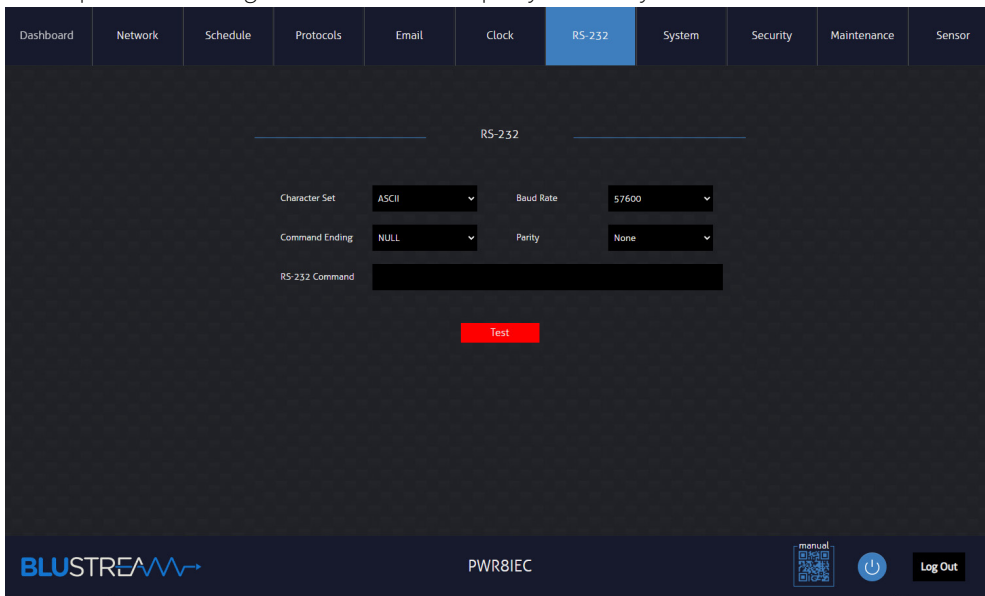

Web-GUI Control - System

The System allows the user to configure, enable and disable certain features of the PWR8IEC, as well controlling whether actions and information are visible on the dashboard.

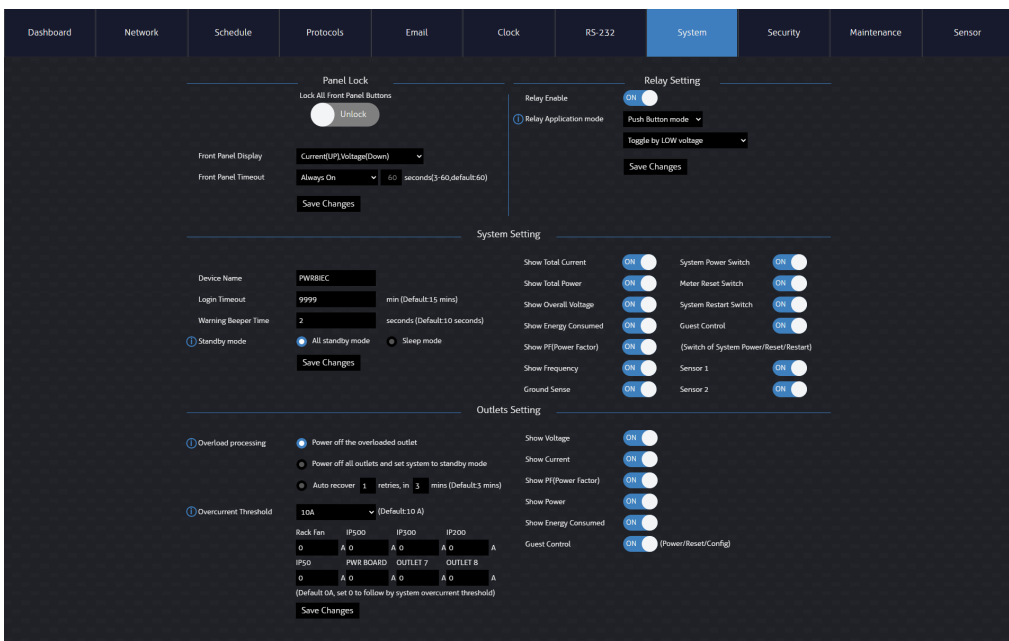

Panel Lock:

The panel lock function enables / disables the front panel power buttons. The default position for this setting is enabled.

When enabled, the powers buttons can be pressed to the toggle the outlet on or off:

- When the outlet is toggled on, the associated LED will be lit blue
- When the outlet is toggled off, the associated LED will be off

Please note: the mains power switch on the left of the front of the unit cannot be disabled.

Front Panel Display	Set which information the front panel display will show
Front Panel Timeout	Set the front panel display to always off, always on, or to turn off after a certain amount of time

Relay Settings:

On the front panel are 5 x relays, with phoenix pin connectors: relays 1-4 for the corresponding outlet, and a fifth relay, 'P', for the mains inlet. The relays can operate in one of two modes, allowing for a high or low voltage to act as the trigger:

Dry Contact Mode:

In this mode, the PWR8IEC will only be controlled by the state on the contact relays for 1-4 and P is disabled, as this could conflict current state of the relays and actual control on GUI, API, and/or front panel.

- Low Voltage to Power ON Outlets:
 - Outlet turns ON when a closed circuit is achieved (external switched closed) connecting Outlet(1-4) relay port to 0V-2.5V or GND or LOW.
 - Outlet turns OFF when an open circuit is achieved (external switched opened) disconnecting Outlet(1-4) relay port to 0V-2.5V or GND or LOW.
- Low Voltage to Power OFF Outlets:
 - Outlet turns OFF when an open circuit is achieved (external switched opened) disconnecting Outlet(1-4) relay port to 0V-2.5V or GND or LOW.
 - Outlet turns ON when a closed circuit is achieved (external switched closed) connecting Outlet(1-4) relay port to 0V-2.5V or GND or LOW.

Push Button Mode: Default (Recommended)

In this mode, the PWR8IEC has an additional mode of control for each port. The external push button will toggle the state of the selected Outlet(1-4). In this mode control on GUI, API, and/or Front panel is available for users.

- Toggle by LOW voltage:
 - External push button switch will act as a toggle switch for Outlet(1-4) when a closed circuit is achieved connecting to 0V-2.5V or GND or LOW.
- Toggle by HIGH voltage:
 - External push button switch will act as a toggle switch for Outlet(1-4) when a closed circuit is achieved connecting to external voltage 2.6V-12V or HIGH.

Relay Settings (continued)

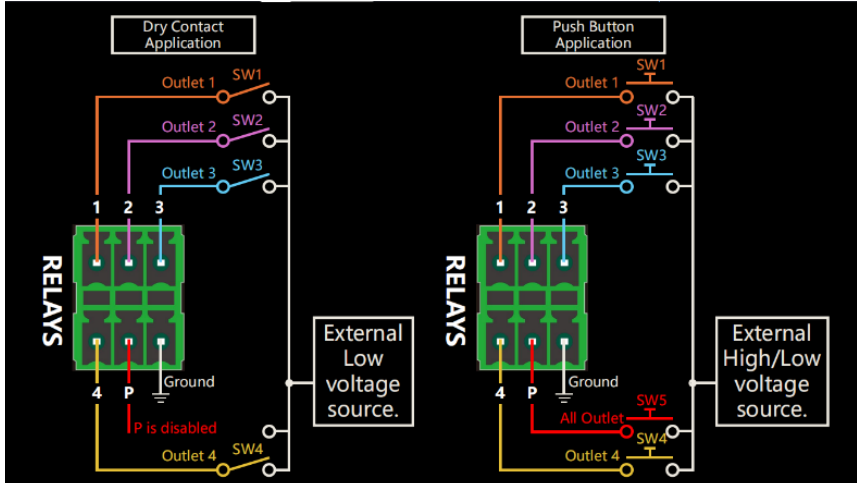

System Settings:

- Device Name Sets the Name of The Device on the GUI
- Login Timeout Sets the inactivity period (in minutes) until the Web-GUI will log the user out
- Warning Beeper Time Sets the duration for the audible warning tone when a warning is triggered (i.e. power surge, overload, over voltage, under voltage)
- Standby Mode Changes how the power button on the Web-GUI and outlet reacts
 - All standby mode: pressing the power button will turn all outlets off and will disable Web-GUI access
 - Sleep mode: pressing the power button will turn all outlets off but will maintain Web-GUI access

Individual toggles can be set to show/hide specific system information under the System Control section on the Dashboard page.

Outlet Settings:

Overload Processing changes how the unit will behave when an overload has been triggered:

- Power off the overloaded outlet
- Power off all outlets and set system to standby mode
- Auto recover 1-3 retries, in 1-10 mins
 - When an overload is detected, the system will try to recover the affected outlet attempting to power it up (max: 3), every specified delay interval (max: 10mins)

Overcurrent Threshold allows for the user to adjust the point at which the current exceeds a threshold to trigger an overload.

- Set the system overcurrent threshold
- Set the overcurrent threshold per outlet (0A will set the outlet to follow the system overcurrent threshold)
- If the current exceeds the threshold, an overcurrent event/alarm will be triggered

The PWR8IEC also features inlet filtering and can detect over voltage and under voltage. More information can be found under the Dashboard section in this manual.

Individual toggles can be set to show/hide specific system information under the System Control section on the Dashboard page.

Web-GUI Control - Security

The Security page is split into two sub pages, toggled by the Admin Credentials or User Authorization tabs at the top of the page:

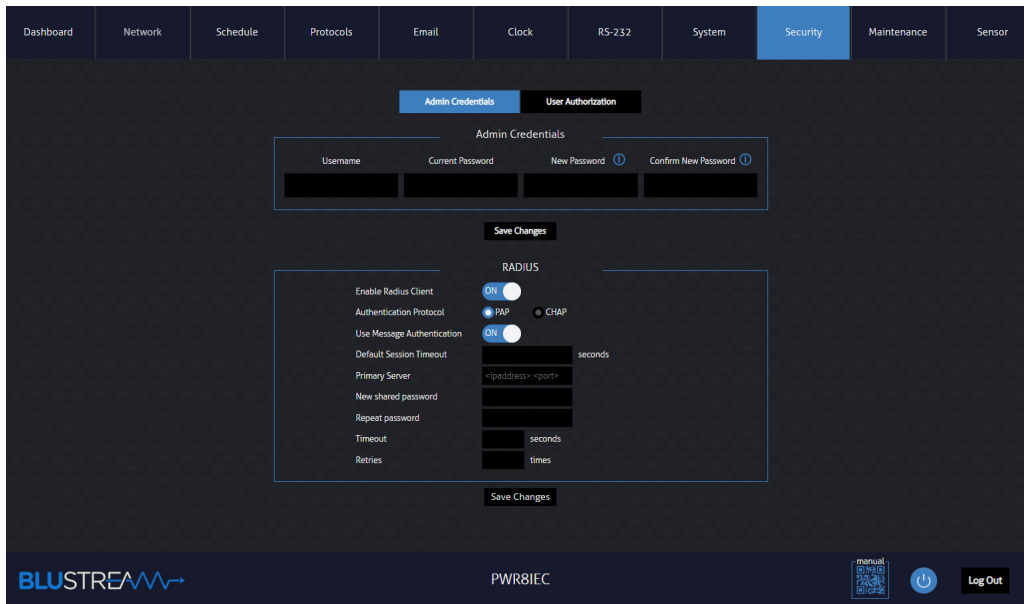

Admin Credentials:

The Admin username and password that was set on first log-in to the GUI is able to be changed.

RADIUS:

Remote Authentication Dial-In User Service (RADIUS) is a networking protocol that can be used to authorize and authenticate remote access users.

A RADIUS client (or Network Access Server) can be set up for 3rd party access with authentication to the PWR8IEC:

Enable RADIUS Client	ON /OFF
Authentication Protocol	PAP / CHAP
Use Message Authentication	This option can be used to sign Access-Requests to prevent spoofing Access-Requests
Default Session Timeout	maximum connect time for the user
Primary Server	IP address of the RADIUS server
New shared password	used as the key for signing hashes
Repeat password	
Timeout	delay between each sign on attempt
Retries	amount of sign on attempts allowed

A Radius setup example has been provided on the following pages:

In this example, we will be using the WinRadius software.

1. Open the WinRadius software

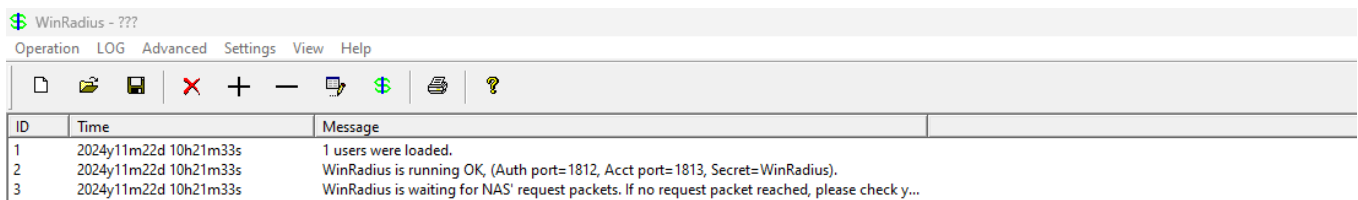

RADIUS (continued)

2. Under Operation/Users..., fill in the fields as shown below.

Use the IP address of the PWR8IEC in the address field. Click confirm to add the account

3. Under Operation/Query..., verify the user has been added

ID	username	status	password	groups	addr	cash	expiry
1	blustream	offline	1234	1234	10.0.0.63	0	2025/01/01

3. Under Settings/System..., set up the shared key, and the accounting port.

4. Complete the Radius settings on the Web-GUI.

- The Authentication Protocol should be set to PAP
- The primary server should be set to the device running the RADIUS server and the accounting port.
- The shared password should be set to the NAS Secret defined in WinRadius

RADIUS (continued)

Enable Radius Client	<input checked="" type="checkbox"/>	ON
Authentication Protocol	<input checked="" type="radio"/> PAP <input type="radio"/> CHAP	
Use Message Authentication	<input checked="" type="checkbox"/>	ON
Default Session Timeout	1800	seconds
Primary Server	10.0.0.63:1813	
New shared password	
Repeat password	
Timeout	0	seconds
Retries	3	times

5. Turn on Telnet under Protocols in the Web-GUI and set 'Use password' to use the 'RADIUS server password'

Use password	RADIUS server password	>> RADIUS settings
Local username	blustream	(Max 12 Char.)
Local password	(Max 8 Char.)

6. Log in using Telnet on the terminal of your choice with the user credentials set in WinRadius

```
10.0.0.60 - PuTTY
Username: blustream
Password: 1234
Please Input Your Command : █
```

User Authorization:

Up to 8 x individual users can be created to allow for individual access to the PWR8IEC Web-GUI, with varying levels of access permissions.

To set up a new user:

- Toggle the desired User # to ON
- Enter a unique username
- Create a password (must adhere to the password guidelines in the Web-GUI Initialization and Log In page)
- Set access permissions by ticking the boxes corresponding to the Web-GUI pages

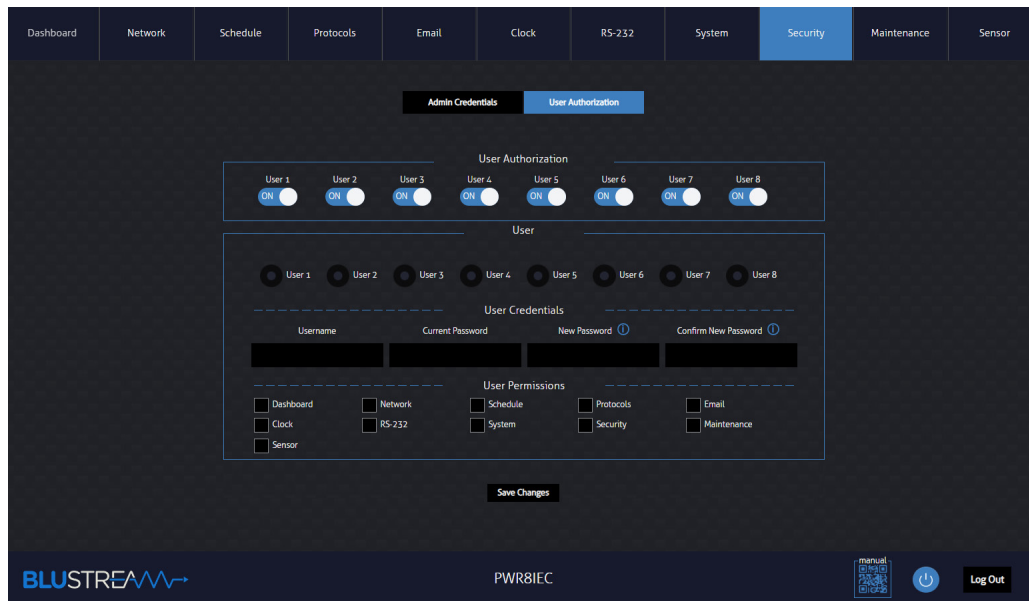

Web-GUI Control - Maintenance

The Maintenance page allows for firmware upgrades, device configurations to be exported, and to access system log.

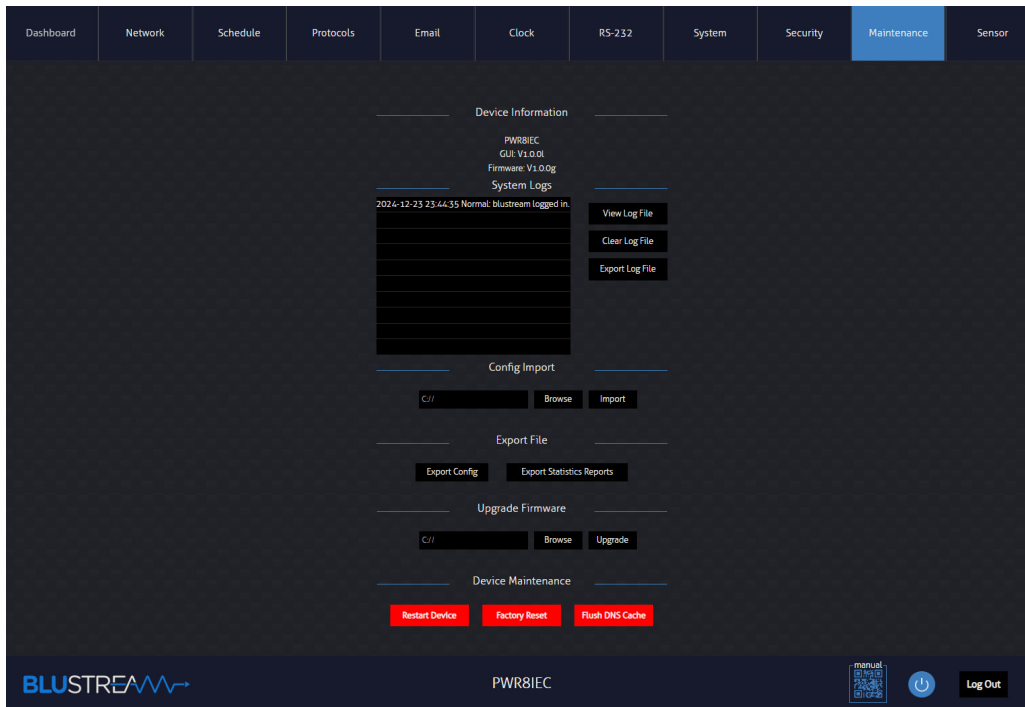

Device Information:

View the current firmware for both the Web-GUI (labelled GUI) and MCU (labelled Firmware) running on the device

System Logs:

All changes to the unit are logged in this section of the Web-GUI. The log can be viewed, cleared, or exported to your laptop / computer.

Config Import:

Allows for the configuration settings to be imported to the unit, overwriting all previously configured settings on the unit

Config Export:

Export the configuration of the unit to a file for back-up, or for copying over to a new unit.

SSL Certificate Upload:

Upload a SSL Certificate for the product to self authenticate on your network.

Upgrade Firmware:

The MCU firmware can be downloaded from the product page on the Blustream website. Please navigate to the Firmware tab to download the most recent firmware package. Press the browse button to locate the MCU firmware file, and then press the Upgrade button to begin the process.

Restart Device: restarts the device, does not affect any previously configured settings on the unit.

Factory Reset: resets the unit back to factory default, including network settings.

Flush DNS Cache: clears any IP addresses, or other DNS records from the cache.

Upgrade Firmware (GUI):

To upgrade the GUI firmware, navigate to the following IP address: `xxx.xxx.xxx.xxx:100` where xxx is the IP address of the PWR81EC. Login with the default username and password:

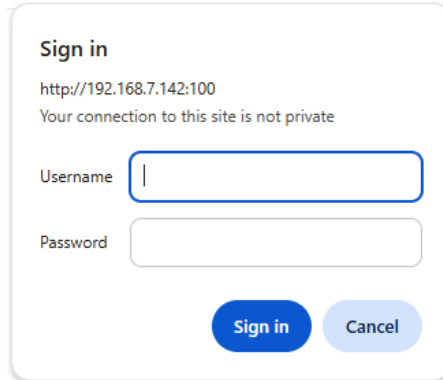

Under the Administration folder, press Upload Firmware:



Press Choose File to locate the GUI firmware file. Once uploaded, press Apply to begin the update:

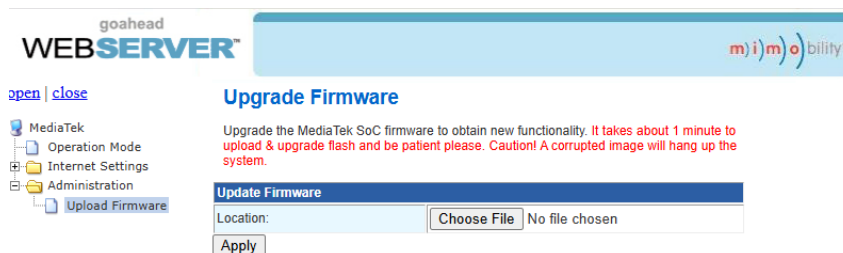

The update takes approximately 3-5min and will disable access to the web-GUI.

Once the web-GUI is accessible again, power cycle the unit.

To confirm the update was successful, please check the GUI version number from the login page or from the Maintenance Page.

Web-GUI Control - Sensors

The Sensor page allows for configuration of external third party sensors to be used with the PWR8IEC.

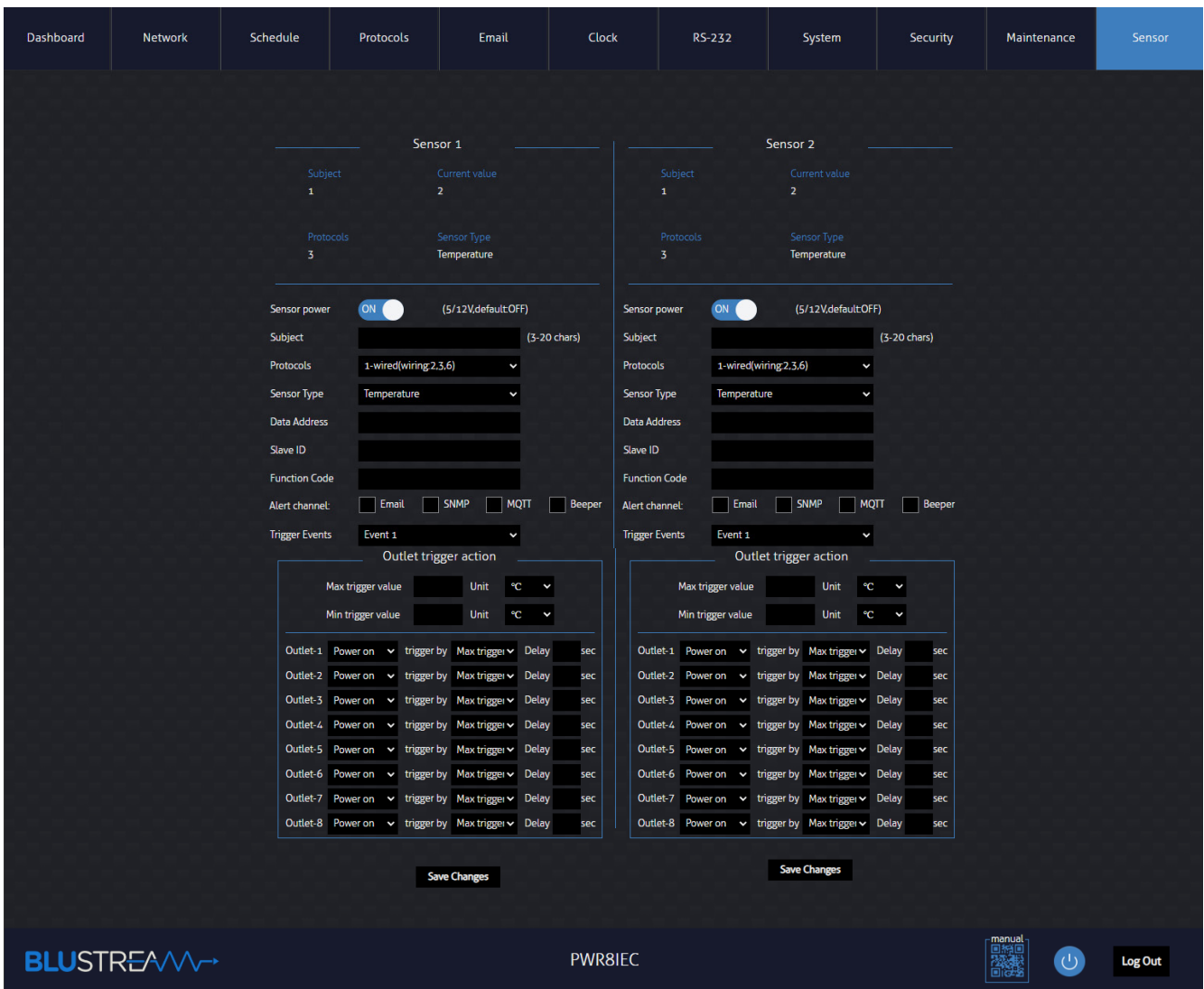

Sensor 1 and Sensor 2:

View the current configuration for Sensor 1 and Sensor 2 including the name, type and current value.

Sensor Power:

Enable or disable the 5V/12V power for this sensor port.

Subject:

Enter a name for this sensor value (3-20 characters).

Protocols:

The sensor port supports various types of sensors which are all wired to an 8 pin RJ45 connector, these should be connected to the Sensor 1 and Sensor 2 ports on the PWR8IEC, the protocols and wiring for these connections are detailed on the next page.

1-Wire Protocol

A common sensor type that might use this protocol is a temperature sensor (For example the DS18B20 temperature sensor).

Protocols: 1-wired(wiring2,3,6)

Sensor Type: Temperature

Data Address: BE

Alert channel: Email SNMP MQTT Beeper

Trigger Events: Event 1

Outlet trigger action

Max trigger value: 10 Unit: °C

Min trigger value: 0 Unit: °C

Outlet-1	No action	trigger by	No trigger	Delay	10	sec
Outlet-2	No action	trigger by	No trigger	Delay	10	sec
Outlet-3	No action	trigger by	No trigger	Delay	10	sec
Outlet-4	No action	trigger by	No trigger	Delay	10	sec
Outlet-5	No action	trigger by	No trigger	Delay	10	sec
Outlet-6	No action	trigger by	No trigger	Delay	10	sec
Outlet-7	No action	trigger by	No trigger	Delay	10	sec
Outlet-8	No action	trigger by	No trigger	Delay	10	sec

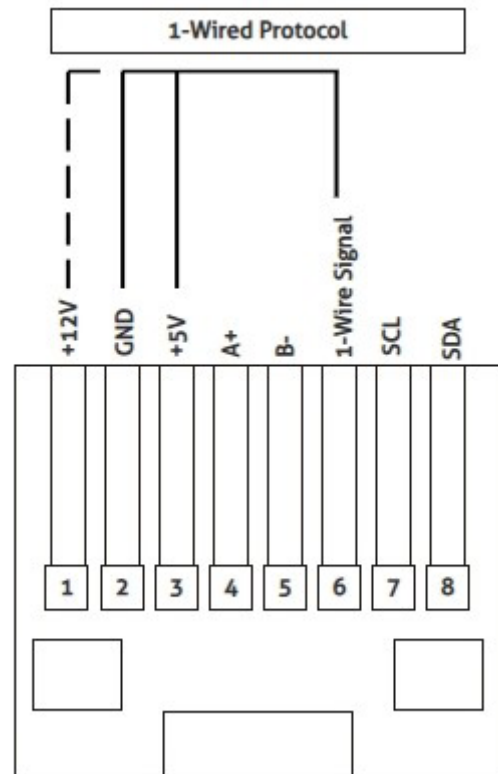

*Note that usually this type of sensor will require 5V power but 12V is available, please use pin 1 when 12V is required.

Protocols:

Select the protocol required: 1-Wired, I2C, Modbus, Relay switch or Door

Sensor type:

Select the sensor type: Temperature, Humidity, Temperature + Humidity, Air Pressure, Other Data.

Data Address:

Enter the data address for the sensor being used, this will usually be found in the sensors user manual and will be a hex code.

Alert Channel:

Select the type of notifications to receive if this sensor is triggered: Email, SNMP, MQTT, Beeper.

Trigger Events:

Up to 3 events can be configured for the sensor, this allows a different event to be triggered if the sensor reaches the min value, max value, or either min or max value. Select Event 1, 2 or 3 to configure each outlets action when one of these events is triggered.

Min/Max Trigger Value & Unit Type:

Enter the minimum and maximum values for the trigger and select the unit type: °C, %RH, hPa.

Outlet action:

For each outlet, select the action that should be taken: No Action, Power On, Power Off, Restart

Then select what this action is triggered by: No Trigger, Min Trigger Value, Max Trigger Value, Min OR Max Trigger Value.

Now enter the delay in seconds before this action takes place once the trigger condition is met.

I2C

A common sensor type that might use this protocol is a humidity and temperature combo sensor, or an air pressure sensor.

Protocols: I2C(wiring:2,3,7,8)
 Sensor Type: Temperature
 Data Address: BE
 Alert channel: Email SNMP MQTT Beeper
 Trigger Events: Event 1
Outlet trigger action
 Max trigger value: 10 Unit: °C
 Min trigger value: 0 Unit: °C

Outlet-1	No action	trigger by	No trigger	Delay	10	sec
Outlet-2	No action	trigger by	No trigger	Delay	10	sec
Outlet-3	No action	trigger by	No trigger	Delay	10	sec
Outlet-4	No action	trigger by	No trigger	Delay	10	sec
Outlet-5	No action	trigger by	No trigger	Delay	10	sec
Outlet-6	No action	trigger by	No trigger	Delay	10	sec
Outlet-7	No action	trigger by	No trigger	Delay	10	sec
Outlet-8	No action	trigger by	No trigger	Delay	10	sec

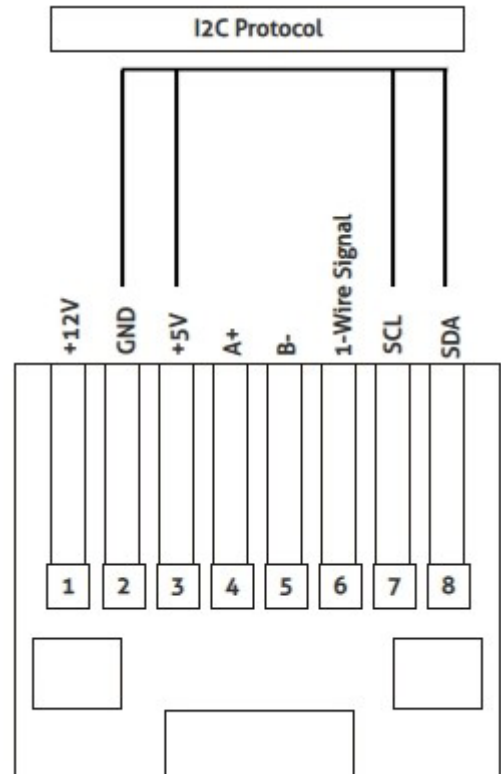

Protocols:

Select the protocol required: 1-Wired, I2C, Modbus, Relay switch or Door

Sensor type:

Select the sensor type: Temperature, Humidity, Temperature + Humidity, Air Pressure, Other Data.

Data Address:

Enter the data address for the sensor being used, this will usually be found in the sensors user manual and would be a hex code.

Alert Channel:

Select the type of notifications to receive if this sensor is triggered: Email, SNMP, MQTT, Beeper.

Trigger Events:

Up to 3 events can be configured for the sensor, this allows a different event to be triggered if the sensor reaches the min value, max value, or either min or max value. Select Event 1, 2 or 3 to configure each outlets action when one of these events is triggered.

Min/Max Trigger Value & Unit Type:

Enter the minimum and maximum values for the trigger and select the unit type: °C, %RH, hPa.

Outlet action:

For each outlet, select the action that should be taken: No Action, Power On, Power Off, Restart

Then select what this action is triggered by: No Trigger, Min Trigger Value, Max Trigger Value, Min OR Max Trigger Value.

Now enter the delay in seconds before this action takes place once the trigger condition is met.

Modbus-RTU on RS-485

A common sensor type that might use this protocol is a humidity and temperature combo sensor, or an air pressure sensor.

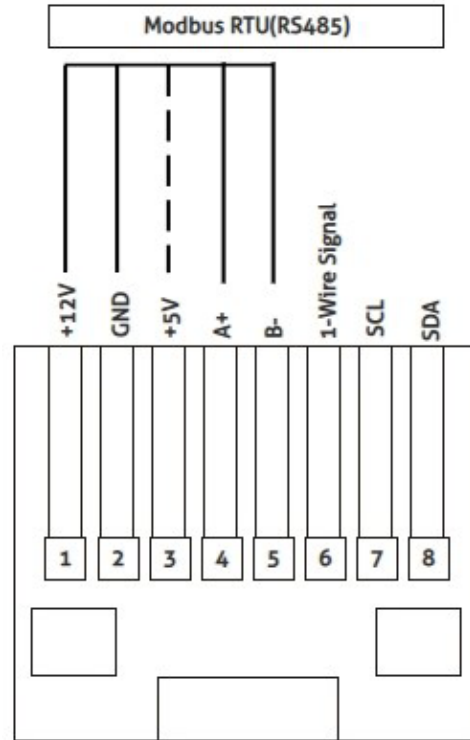
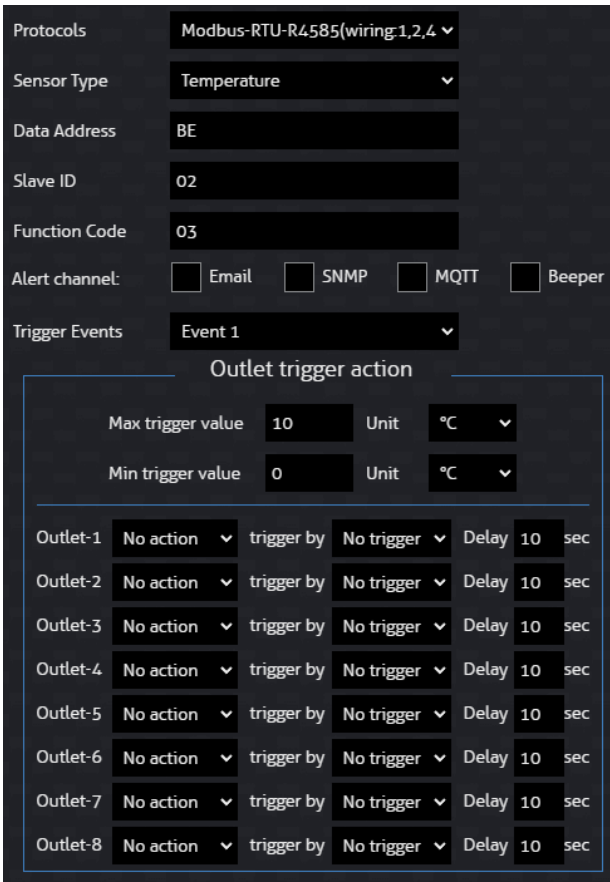

*Note that usually this type of sensor will require 12V power but 5V is available, please use pin 3 when 5V is required.

Protocols:

Select the protocol required: 1-Wired, I2C, Modbus, Relay switch or Door

Sensor type:

Select the sensor type: Temperature, Humidity, Temperature + Humidity, Air Pressure, Other Data.

Data Address:

Enter the data address for the sensor being used, this will usually be found in the sensors user manual and would be a hex code.

Slave ID:

Enter the Slave ID for the sensor being used, this will usually be found in the sensors user manual

Function Code:

Enter the Function Code for the sensor being used, this will usually be found in the sensors user manual

Alert Channel:

Select the type of notifications to receive if this sensor is triggered: Email, SNMP, MQTT, Beeper.

Trigger Events:

Up to 3 events can be configured for the sensor, this allows a different event to be triggered if the sensor reaches the min value, max value, or either min or max value. Select Event 1, 2 or 3 to configure each outlets action when one of these events is triggered.

Min/Max Trigger Value & Unit Type:

Enter the minimum and maximum values for the trigger and select the unit type: °C, %RH, hPa.

Outlet action:

For each outlet, select the action that should be taken: No Action, Power On, Power Off, Restart

Then select what this action is triggered by: No Trigger, Min Trigger Value, Max Trigger Value, Min OR Max Trigger Value.

Now enter the delay in seconds before this action takes place once the trigger condition is met.

Relay Switch Sensor:

A common sensor type that might use this protocol is a PIR sensor.

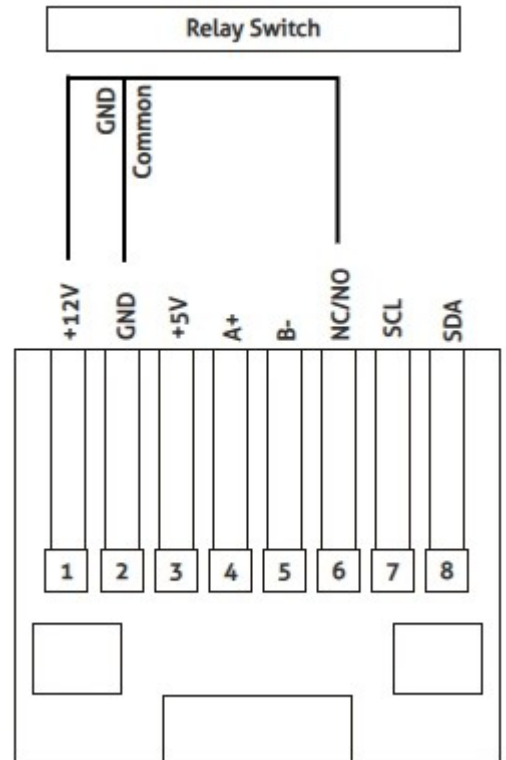
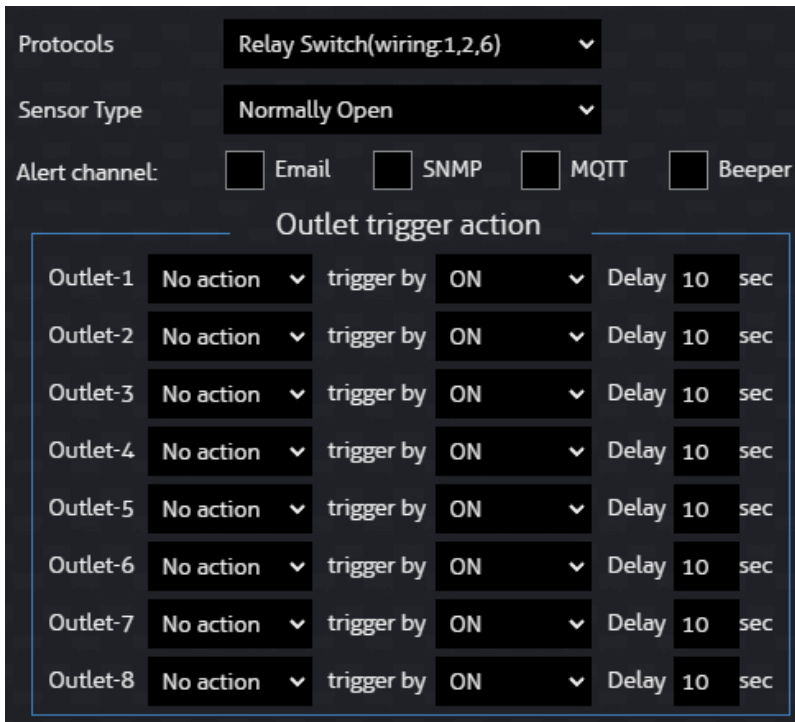

Protocols:

Select the protocol required: 1-Wired, I2C, Modbus, Relay switch or Door

Sensor type:

Select the sensor type Normally Open or Normally Closed based on the logic of the sensor being used.

Alert Channel:

Select the type of notifications to receive if this sensor is triggered: Email, SNMP, MQTT, Beeper.

Outlet action:

For each outlet, select the action that should be taken: No Action, Power On, Power Off, Restart

Then select what this action is triggered by: No Trigger, ON or OFF.

Now enter the delay in seconds before this action takes place once the trigger condition is met.

Magnetic Door Sensor

A common sensor type that might use this protocol is a door sensor.

Protocols: **Door(wiring:2,6)**

Sensor Type: **Normally Open**

Alert channel: Email SNMP MQTT Beeper

Outlet trigger action

Outlet-1	No action	trigger by	ON	Delay	10	sec
Outlet-2	No action	trigger by	ON	Delay	10	sec
Outlet-3	No action	trigger by	ON	Delay	10	sec
Outlet-4	No action	trigger by	ON	Delay	10	sec
Outlet-5	No action	trigger by	ON	Delay	10	sec
Outlet-6	No action	trigger by	ON	Delay	10	sec
Outlet-7	No action	trigger by	ON	Delay	10	sec
Outlet-8	No action	trigger by	ON	Delay	10	sec

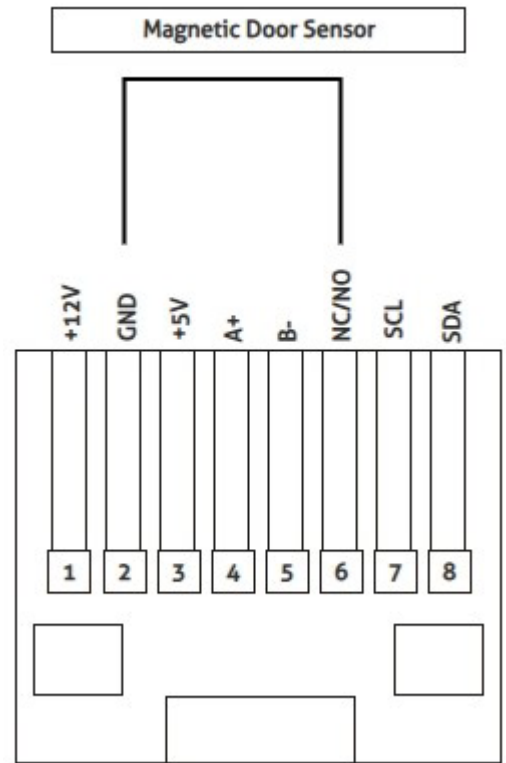

Protocols:

Select the protocol required: 1-Wired, I2C, Modbus, Relay switch or Door

Sensor type:

Select the sensor type Normally Open or Normally Closed based on the logic of the sensor being used.

Alert Channel:

Select the type of notifications to receive if this sensor is triggered: Email, SNMP, MQTT, Beeper.

Outlet action:

For each outlet, select the action that should be taken: No Action, Power On, Power Off, Restart

Then select what this action is triggered by: No Trigger, ON or OFF.

Now enter the delay in seconds before this action takes place once the trigger condition is met.

Specifications

- **Power Input Ports:** 1 x C20 IEC 16A
- **Power Output Ports:** 8 x C13 IEC 10A (Controllable) 1 x C13 IEC 10A (Constant)
- **Relay Control:** 4 x 3-Pin Phoenix connector
- **RS-232 Serial Port:** 1 x 3-Pin Phoenix connector
- **TCP/IP Control:** 2 x RJ45, female
- **Sesnor Ports:** 2 x RJ45, female
- **Rack-Mountable:** 1U rack height, rack ears included
- **Casing Dimensions (W x D x H):** 437mm x 225mm x 44mm
- **Casing Dimensions (including connections) (W x D x H):** 437mm x 234mm x 44mm
- **Shipping Weight:** 3.0kg TBC
- **Operating Temperature:** 32°F to 104°F (0°C to 40°C)
- **Storage Temperature:** -4°F to 140°F (-20°C to 60°C)
- **Power Input:** 110-250V AC

NOTE: Specifications are subject to change without notice. Weights and dimensions are approximate.

Package Contents

- 1 x PWR8IEC
- 1 x Serial cable - 3 pin Phoenix to DB9 connector
- 4 x 3 pin 3.5mm Phoenix connectors (for Relay ports)
- 1 x 19" Rack Mounting kit
- 4 x Mounting feet
- 1 x Quick Reference Card
- IEC Power Cable(s)

Please note: outlet IEC outlet cabling is not supplied for this product

Maintenance

Clean this unit with a soft, dry cloth. Never use alcohol, paint thinner or benzene to clean this unit.

RS-232 Configuration and Telnet Commands

The PWR8IEC can be controlled via serial and TCP/IP.

The default RS-232 communication settings are:

Baud rate: 57600

Data bit: 8

Stop bit: 1

Parity bit: none

The following pages list all available serial / IP commands.

Commonly used Serial Commands

There are several commands that are commonly used for control and testing:

STATUS	Status will give feedback on the unit such as outputs on, type of connection etc...
PON	Power on
POFF	Power off
RELAY ON/OFF	Toggling the relay input / output control ON or OFF as required
Example:-	RELAYON (This would turn the ability for the relays to trigger events on)
OUTLET xx ON	(xx is the outlet)
Example:-	OUTLET04ON (This would switch outlet 4 to ON)

Common Mistakes

- Carriage return – Some programs do not require the carriage return where as other will not work unless sent directly after the string. In the case of some Terminal software the token <CR> is used to execute a carriage return. Depending on the program you are using this token maybe different. Some other examples that other control systems deploy include \r or 0D (in hex)
- Spaces – Blustream commands do not require space between commands unless specified. There may be some programs that require spacing in order to work.
 - How the string should look is as follows OUTLET04ON
 - How the string may look if spaces are required: OUTLET{Space}04{Space}ON
- Baud rate or other serial protocol settings not correct

RS-232 Configuration and Telnet Commands

COMMAND	ACTION
? / HELP	Print help information
STATUS	Print system status and port status
ELESTA	Print All Outputs Electricity Level Information
FWVERSION	Print FW Version And GUI Version
DEVICENAME:xx	Set Device Name To xx
PON	Set System Power to ON
POFF	Set System Power to OFF
RELAY ON/OFF	Set System RELAY Control ON Or OFF
KEY ON/OFF	Set System Key Control ON Or OFF
RESET	Reset System To Default Setting(Type "Yes" To Confirm, "No" To Discard)
REBOOT	Set System Reboot And Apply New Config!!!
RESTA	Set System Restart
SETCURRENTTHRESH-OLD xx	Set System Current Threshold To xx (xx to one decimal place at most) xx = 0.0 : 10.9
SAFEMODE xx	Set The System Safe Mode To xx When Overloaded xx=0 Outlet_Shutdown 1 System_Shutdown 2 Auto_Retry
OVERLOADRETRYCNT xx	Set The System Retry Number To xx When Overloaded(Default: 1) xx = 1 : 3
OVERLOADRETRY-TIME xx	Reset System To Default Setting
STANDBYMODE xx	Set The System Standby Mode To xx xx = 0 All_Standby_Mode 1 Sleep_Mode
RELAYMODE xx	Set The System Relay Mode To xx xx = 0 Dry_Contact 1 Push_Button
RELAYVOLTAGE xx	Set The System Relay Toggle Voltage To xx xx = 0 Low_Voltage 1 High_Voltage
BEEPERTIME xx	Set The Buzzer Sound Time To xx Seconds When Alarming (Default: 10 Seconds) xx = 0 : 9999
OUTLETTIMEON xx:yy	Set Outlet xx Power_ON Delay To yy Seconds xx = 1 Outlet 1 2 Outlet 2 3 Outlet 3 4 Outlet 4 5 Outlet 5 6 Outlet 6 7 Outlet 7 8 Outlet 8 yy = 0 : 9999
OUTLETTIMEOFF xx:yy	Set Outlet xx Power_OFF Delay To yy Seconds xx = 1 Outlet 1 2 Outlet 2 3 Outlet 3 4 Outlet 4 5 Outlet 5 6 Outlet 6 7 Outlet 7 8 Outlet 8 yy = 0 : 9999

COMMAND	ACTION
OUTLETELERESET xx:yy	Set Outlet xx Electrical Work Reset Duration To yy Seconds (Default: 10 Seconds) xx = 1 Outlet 1 2 Outlet 2 3 Outlet 3 4 Outlet 4 5 Outlet 5 6 Outlet 6 7 Outlet 7 8 Outlet 8 yy = 0 : 9999
ALLOUT ON/OFF	Set All Outlets ON/OFF
OUTLET xx ON/OFF	Set Outlet xx ON/OFF xx = 1 Outlet 1 2 Outlet 2 3 Outlet 3 4 Outlet 4 5 Outlet 5 6 Outlet 6 7 Outlet 7 8 Outlet 8
RSALLOUTELE	Clean Up All Outlets Electrical Work
RSOUTELE xx	Clean Up The Outlet xx Electrical Work xx = 1 Outlet 1 2 Outlet 2 3 Outlet 3 4 Outlet 4 5 Outlet 5 6 Outlet 6 7 Outlet 7 8 Outlet 8
SYSTIME	Get The Time For The System
RESYSTIME yyyy-mm-dd;hh:mm:ss	Set The Time For The System yyyy = Year mm = Month dd = Day hh = Hour mm = Minute ss = Second
LED ON/OFF	Set LCD Screen to Always ON/OFF.
LED xx	Set LCD Screen To Auto Turn Off After xxS(Default: 60 Seconds)
RS232OUT y:z:c:a	Send y Type Of Command a With Baud Rate z, Parity c To Output y=a: ASCII y=h: HEX z=1: 2400 z=2: 4800 z=3: 9600 z=4: 19200 z=5: 38400 z=6: 57600(Default) z=7: 115200 c=1: None c=2: Even c=3: Odd a=RS232 Command
RS232BAUD z	Set RS232 Baud Rate To xx z = 1 - 2400 2 - 4800 3 - 9600 4 - 19200 5 - 38400 6 - 57600(Default) 7 - 115200
SENSOR1/SENSOR2 POWER xx	Set Sensor 1/Sensor 2 Power To xx xx = 0 OFF 1 ON

RS-232 Configuration and Telnet Commands

COMMAND	ACTION
SENSOR1/SENSOR2 PROTOCOLS xx	Set SENSOR1/SENSOR2 Protocols To xx xx = 1 1-wire(wiring2,3,6) 2 I2C(wiring2,3,7,8) 3 Modbus-RTU-RS485 (wiring1,2,4,5) 4 Door(wiring2,6) 5 Relay Switch(wiring1,2,6)
SENSOR1/SENSOR2 TYPE xx	Set SENSOR1/SENSOR2 Type To xx xx = 1 Temperature 2 Humidity 3 Temperature And Humidity 4 Air Pressure 5 Other Data 6 Normally Open 7 Normally Close
SENSOR1/SENSOR2 ADDRESS xx	Set SENSOR1/SENSOR2 Data Address To xx xx = 00 : FF or 0000 : FFFF
SENSOR1/SENSOR2 MSADDRESS xx	Set SENSOR1/SENSOR2 Slave Station Address To xx xx = 00 : FF
SENSOR1/SENSOR2 MFUNCCODE xx	Set SENSOR1/SENSOR2 Function Code To xx xx = 03 or 04
SENSOR1/SENSOR2 TRIGGEREVENT xx	Set SENSOR1/SENSOR2 Trigger Event To xx xx = 1 : 3
SENSOR1/SENSOR2 VALUEMAX xx	Set SENSOR1/SENSOR2 Max Value To xx xx = 0 : 9999
SENSOR1/SENSOR2 VALUEMIN xx	Set SENSOR1/SENSOR2 Min Value To xx xx = 0 : 9999
SENSOR1/SENSOR2 UNIT xx	Set SENSOR1/SENSOR2 Unit To xx xx = 1 °C 2 %RH 3 hPa
SENSOR1/SENSOR2 BEEPER ON/OFF	Set SENSOR1/SENSOR2 Beeper ON/OFF
SENSOR1/SENSOR2 OUTLETMODE xx:yy	Set Outlet xx Response Sensor1/Sensor2 Mode To yy xx = 1 Outlet1 2 Outlet2 3 Outlet3 4 Outlet4 5 Outlet5 6 Outlet6 7 Outlet7 8 Outlet8 yy = 1 No Action 2 Power ON 3 Power OFF 4 Restart
SENSOR1/SENSOR2 OUTLETTRIGGER xx:yy	Set Outlet xx Response Sensor1/Sensor2 Trigger To yy xx = 1 Outlet1 2 Outlet2 3 Outlet3 4 Outlet4 5 Outlet5 6 Outlet6 7 Outlet7 8 Outlet8 yy = 1 No Trigger 2 Max Trigger 3 Min Trigger 4 Max Or Min 5 ON 6 OFF

COMMAND	ACTION
SENSOR1/SENSOR2 OUTLETDELAY xx:yy	Set Outlet xx Response Sensor1/Sensor2 Delay To yy xx = 1 Outlet1 2 Outlet2 3 Outlet3 4 Outlet4 5 Outlet5 6 Outlet6 7 Outlet7 8 Outlet8 yy = 0 : 9999
GET SENSOR1/SENSOR2 CURRENT	Get Sensor1/Sensor2 Current Value xx
NET TCP/IP ENABLE xx	Set TCP/IP xx Enable(Only One Can Be Enabled) xx = 1 TCP/IP1 2 TCP/IP2
NET TCP/IP1 DHCP ON/OFF	Set TCP/IP1 Auto IP (DHCP) ON or OFF
NET TCP/IP1 IP xxx.xxx.xxx.xxx	Set TCP/IP1 IP Address
NET TCP/IP1 GW xxx.xxx.xxx.xxx	Set TCP/IP1 Gateway Address
NET TCP/IP1 SM xxx.xxx.xxx	Set TCP/IP1 Subnet Mask Address
NET TCP/IP2 DHCP ON/OFF	Set TCP/IP2 Auto IP (DHCP) ON or OFF
NET TCP/IP2 IP xxx.xxx.xxx.xxx	Set TCP/IP2 IP Address
NET TCP/IP2 GW xxx.xxx.xxx.xxx	Set TCP/IP2 Gateway Address
NET TCP/IP2 SM xxx.xxx.xxx	Set TCP/IP2 Subnet Mask Address
NET MDNS ON/OFF	Set mDNS ON/OFF
NET RB	Set Network Reboot and Apply New Config

*** Please note:** Only highlighted commands are available in MQTT API Control.

Schematic

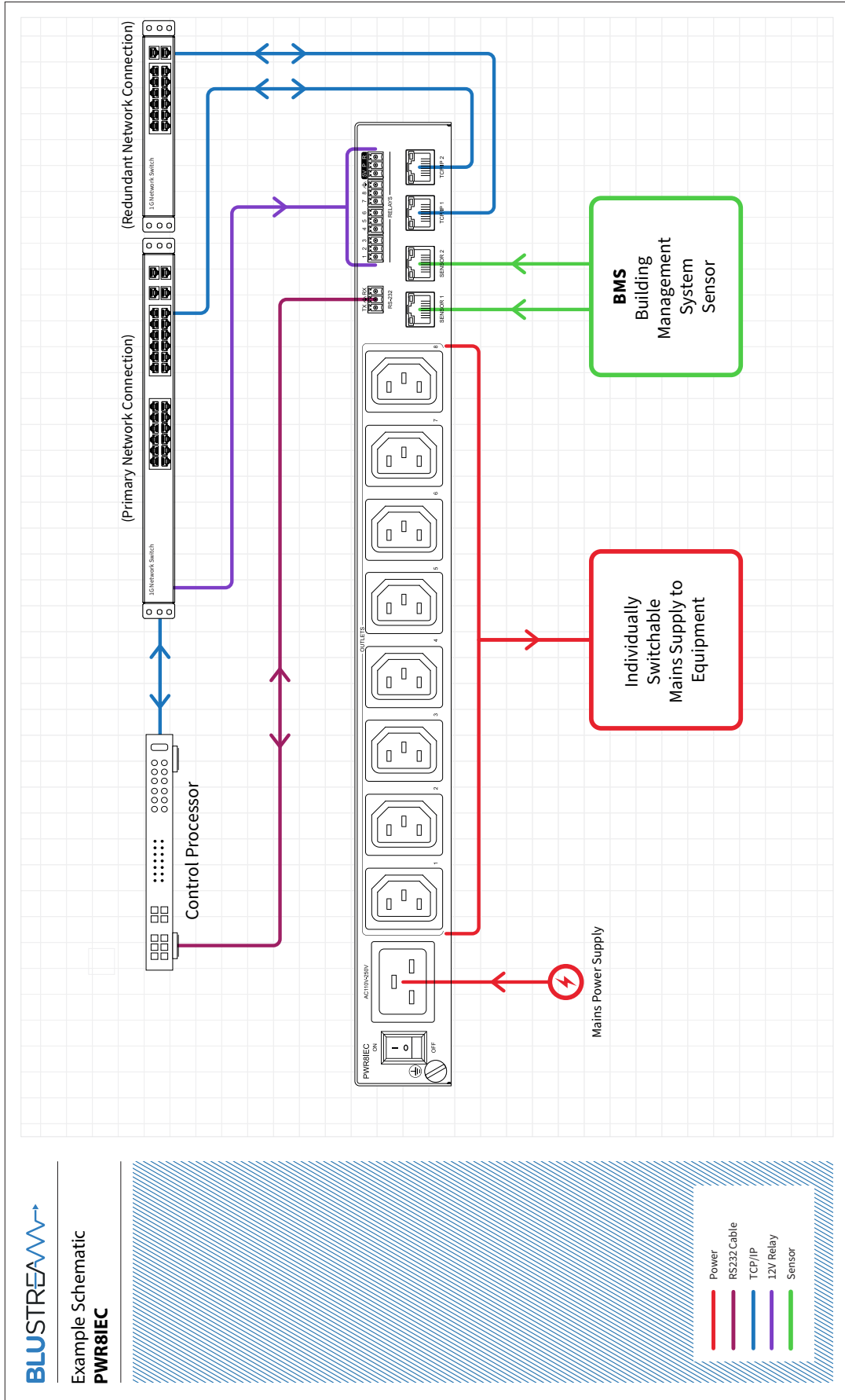

Certifications

FCC Notice

This equipment has been tested and found to comply with the limits for a Class B digital device, pursuant to part 15 of the FCC Rules. These limits are designed to provide reasonable protection against harmful interference in a residential installation. This equipment generates, uses, and can radiate radio frequency energy and, if not installed and used in accordance with the instructions, may cause harmful interference to radio communications. However, there is no guarantee that interference will not occur in a particular installation. If this equipment does cause harmful interference to radio or television reception, which can be determined by turning the equipment off and on, the user is encouraged to try to correct the interference by one or more of the following measures:

- Reorient or relocate the receiving antenna.
- Increase the separation between the equipment and receiver.
- Connect the equipment into an outlet on a circuit different from that to which the receiver is connected.
- Consult the dealer or an experienced radio/TV technician for help.

CAUTION - changes or modifications not expressly approved by the party responsible for compliance could void the user's authority to operate the equipment.

CANADA, INDUSTRY CANADA (IC) NOTICES

This Class B digital apparatus complies with Canadian ICES-003.

Operation is subject to the following two conditions: (1) this device may not cause interference, and (2) this device must accept any interference, including interference that may cause undesired operation of the device.

CANADA, AVIS D'INDUSTRY CANADA (IC)

Cet appareil numérique de classe B est conforme aux normes canadiennes ICES-003.

Son fonctionnement est soumis aux deux conditions suivantes : (1) cet appareil ne doit pas causer d'interférence et (2) cet appareil doit accepter toute interférence, notamment les interférences qui peuvent affecter son fonctionnement.

CORRECT DISPOSAL OF THIS PRODUCT

This marking indicates that this product should not be disposed with other household wastes. To prevent possible harm to the environment or human health from uncontrolled waste disposal, recycle it responsibly to promote the sustainable reuse of material resources. To return your used device, please use the return and collection systems or contact the retailer where the product was purchased. They can take this product for environmentally safe recycling.



Installer Notes



www.blustream.com.au
www.blustream-us.com
www.blustream.co.uk